



**US Army Corps  
of Engineers**

EM 1110-2-1202  
29 May 1987

**ENGINEERING AND DESIGN**

---

# **Environmental Engineering for Deep-Draft Navigation Projects**

**ENGINEER MANUAL**

Engineer Manual  
No. 1110-2-1202

29 May 1987

Engineering and Design  
ENVIRONMENTAL ENGINEERING FOR DEEP-DRAFT  
NAVIGATION PROJECTS

1. Purpose. This manual provided guidance for incorporating environmental considerations in the planning, engineering and design, as well as, construction, operation and maintenance of deep-draft navigation projects.
2. Applicability. This manual applies to all HQUSACE/OCE and field operating activities (FOAs) having responsibility for the engineering and design of civil works projects.
3. Discussion. Deep-draft navigation projects involve development of large channel systems with attendant turning basins, anchorages, and pier and wharfing facilities. Construction and maintenance of deep-draft navigation projects usually involve dredging large volumes of bottom sediment and resultant changes in bottom geometry of the water body. Environmental considerations associated with these actions include those related to dredging and disposal of dredged material, and the possible alteration of water circulation patterns, salinity concentrations, water levels, flushing rates, and habitats. This manual provides guidance on incorporating environmental considerations as part of deep-draft project design and construction, as well as guidance for incorporating project features for attaining environmental quality objectives.

FOR THE COMMANDER:



ARTHUR E. WILLIAMS  
Colonel, Corps of Engineers  
Chief of Staff

Engineer Manual  
No. 1110-2-1202

Engineering and Design  
ENVIRONMENTAL ENGINEERING FOR DEEP-DRAFT NAVIGATION PROJECTS

Table of Contents

<u>Subject</u>		<u>Paragraph</u>	<u>Page</u>
CHAPTER 1.	INTRODUCTION		
	Purpose-----	1-1	1-1
	Scope-----	1-2	1-1
	Applicability-----	1-3	1-1
	References-----	1-4	1-1
	Bibliography-----	1-5	1-2
	Background-----	1-6	1-2
	Definitions-----	1-7	1-3
CHAPTER 2.	GENERAL ENVIRONMENTAL CONSIDERATIONS		
	Study Requirements-----	2-1	2-1
	Hydraulic Design Aspects-----	2-2	2-6
	Water Quality Considerations-----	2-3	2-10
	Biological Considerations-----	2-4	2-11
	Recreational Considerations-----	2-5	2-18
	Aesthetics-----	2-6	2-18
	Cultural Resources-----	2-7	2-20
	Winter Navigation-----	2-8	2-23
CHAPTER 3.	ENVIRONMENTAL CONSIDERATIONS IN DESIGN		
	Circulation and Water Quality-----	3-1	3-1
	Prevention and Control of Salinity Intrusion-----	3-2	3-7
	Sedimentation Effects-----	3-3	3-10
	Biological Considerations-----	3-4	3-15
	Dredging Effects Considerations-----	3-5	3-17
	Associated Activities-----	3-6	3-22
CHAPTER 4.	ENVIRONMENTAL CONSIDERATIONS IN CONSTRUCTION, OPERATION, AND MAINTENANCE		
	Dredging and Dredged Material Disposal-----	4-1	4-1
	Navigation Traffic-----	4-2	4-15
CHAPTER 5.	ENVIRONMENTAL DATA COLLECTION AND ANALYSIS		
	General Considerations-----	5-1	5-1
	Monitoring Program-----	5-2	5-2
	Data Collection-----	5-3	5-6

<u>Subject</u>	<u>Paragraph</u>	<u>Page</u>
Data Analysis, Interpretation, and Presentation of Results-----	5-4	5-15
Database Management-----	5-5	5-20
Water Quality and Biological Data Collection Considerations-----	5-6	5-21
 CHAPTER 6. MITIGATION DECISION ANALYSIS		
Policy-----	6-1	6-1
Definitions-----	6-2	6-1
Justification for Mitigation-----	6-3	6-1
Key Concepts for Mitigation-----	6-4	6-1
 CHAPTER 7. CHECKLIST OF STUDIES		7-1
 APPENDIX A. BIBLIOGRAPHY		A-1
 APPENDIX B. MATHEMATICAL MODELING		B-1
 APPENDIX C. USE OF PHYSICAL HYDRAULIC MODELS AS TOOLS IN DEEP-DRAFT ENVIRONMENTAL STUDIES		C-1
 GLOSSARY		Glossary-1

29 May 87

## CHAPTER 1

## INTRODUCTION

1-1. Purpose. The purpose of this manual is to provide guidance for incorporating environmental considerations in planning, engineering and design, construction, operation, and maintenance of deep-draft navigation projects.

1-2. Scope. Deep-draft navigation projects involve development of large channel systems with attendant turning basins, anchorages, and pier and wharfing facilities. Construction and maintenance of deep-draft navigation projects usually involve dredging large volumes of bottom sediment and resultant changes in bottom geometry of the water body. Environmental considerations associated with these actions include those related to dredging and disposal of dredged material, and the possible alteration of water circulation patterns, salinity concentrations, water levels, flushing rates, and habitats. This manual provides guidance on incorporating environmental considerations as part of deep-draft project design and construction, as well as guidance for incorporating project features for attaining environmental quality objectives. This manual is intended to be compatible with engineer manual EM 1110-2-1613, "Hydraulic Design of Deep-Draft Navigation Projects." The intended audience of this manual includes those engineers and scientists currently involved in planning studies, project design, operation, maintenance, and regulatory functions associated with deep-draft navigation projects.

1-3. Applicability. This manual applies to all field operating activities having civil works responsibilities, and is applicable across all functional areas (i.e., planning, design, construction, operation, and maintenance).

1-4. References. The references listed below provide practical guidance to Corps personnel concerned with the planning, design, construction, operation, and maintenance of deep-draft navigation projects.

- a. ER 200-2-2, Policy for Procedures for Implementing NEPA.
- b. ER 1105-2-10, Planning Program.
- c. ER 1105-2-20, Project Purpose Planning Guidance.
- d. ER 1105-2-50, Environmental Resources.
- e. ER 1110-2-400, Design of Recreation Sites, Areas, and Facilities.
- f. ER 1110-2-1404, Deep-Draft Navigation Project Design.
- g. EM 1110-2-1612, Ice Engineering.
- h. EM 1110-2-1613, Hydraulic Design of Deep-Draft Navigation Projects.
- i. EM 1110-2-5025, Dredging and Dredged Material Disposal.
- j. EP 1165-2-1, Digest of Water Resources Policies and Authorities.

29 May 87

k. Miscellaneous Paper D-76-17, "Ecological Evaluation of Proposed Discharge of Dredged or Fill Material into Navigable Waters; Interim Guidance for Implementation of Section 404(b)(1) of Public Law 92-500 (Federal Water Pollution Control Acts Amendment of 1972)." Available from US Army Engineer Waterways Experiment Station, PO Box 631, Vicksburg, Miss. 39180.

1-5. Bibliography. Bibliographic information throughout the manual is denoted by author and date corresponding to the listing in Appendix A. These documents are available for loan upon request to the US Army Engineer Waterways Experiment Station (WES) Technical Information Center Library, PO Box 631, Vicksburg, Miss. 39180.

1-6. Background.

a. Deep-Draft Project Characterization. Deep-draft navigation projects are those for vessel drafts in excess of 15 feet. They comprise practically all commercial coastal ports in the United States, the lower portions of the Mississippi and Columbia Rivers, and a majority of harbors within the Great Lakes system. There is increased emphasis on expanding the capacity of these projects by deepening to accommodate the trend toward deeper draft ships in the world fleet. Several deepening projects are now in various stages of planning, design, and construction. The detailed consideration of environmental factors is as important as economic feasibility in the expeditious completion and continued maintenance of these projects. Potential problems regarding the environmental considerations may be a major factor in determining the overall feasibility of a project.

b. Manual Development. The information contained in this manual summarizes the results of research in related fields and the experience of Corps personnel involved in deep-draft projects. The manual outline was developed by an interdisciplinary committee composed of personnel from the WES laboratories and other Corps laboratories, with review and comments provided by the US Army Corps of Engineers. The text was prepared by personnel of the WES Environmental and Hydraulics Laboratories; other Corps laboratories provided brief inputs and reviews. A wide spectrum of subdisciplines and specialties was represented among the authors. Information generated by the following research programs was used to produce this manual:

(1) Aquatic Plant Control Research Program (APCRP). The main objective of the APCRP is to develop technology for controlling aquatic plant infestations in an environmentally compatible manner at the least possible cost. Comprehensive solutions are sought that involve the use of biological, chemical, mechanical, and integrated control agents. The Environmental Laboratory is the Corps' lead research laboratory for aquatic plant control research.

(2) Dredged Material Research Program (DMRP) and Dredging Operations Technical Support (DOTS). The major objectives of the DMRP, which has been completed, were to provide definitive information on the environmental impact of dredging and dredged material disposal operations and to develop new or improved dredged material disposal practices. The research was conducted on a national basis and included all major types of dredging activity, region, or environmental setting. It produced methods for evaluating the physical, chemical, and biological impacts of a variety of disposal alternatives in water, on

land, or in wetland areas, as well as tested, viable, cost-effective methods and guidelines for reducing the impacts of conventional disposal alternatives. The DMRP also included research using dredged material for the development of fish and wildlife habitat. WES TR DS-78-23 (Herner and Company 1980) provides an index of DMRP reports. The major objectives of the DOTS program are to verify DMRP findings and to provide technical support to the Corps regarding dredging and disposal.

(3) Environmental and Water Quality Operational Studies (EWQOS). The EWQOS program was initiated to solve high-priority environmental problems, primarily those related to reservoirs and inland waterways. However, some transfer of information to deep-draft and coastal area projects is possible.

(4) Natural Resources Research Program (NRRP). The NRRP seeks to address Corps recreation problems. Major categories of research include planning, design, and management problems related to carrying capacity, visitor safety, concessions, and contracting out operation and maintenance operations.

(5) Environmental Impact Research Program (EIRP). The EIRP consists of research on environmental problems not currently covered by other major programs.

(6) Improvement of Operation and Maintenance Techniques (IOMT). The IOMT program is directed towards obtaining maximum economy, safety, efficiency, and energy conservation in the reduction of navigation channel shoaling, the removal of dredged materials, and general maintenance and operations.

(7) Flood Control Hydraulics Research Program (FCHRP). The FCHRP develops improved guidance for the design, operation, and maintenance of flood channels and related hydraulic structures. Since many of the Corps' flood control activities involve multipurpose projects that impact navigation research, results from this program are often pertinent to the evaluation of deep-draft navigation projects.

(8) Navigation Hydraulics Research Program (NHRP). The NHRP seeks cost-effective, environmentally acceptable means of providing safe and efficient deep- and shallow-draft navigation channels with minimum dredging.

1-7. Definitions. An explanation of terms frequently encountered by users of this manual is provided in the Glossary.

## CHAPTER 2

### GENERAL ENVIRONMENTAL CONSIDERATIONS

#### 2-1. Study Requirements.

a. General. Both new projects and operation and maintenance activities must be consistent with national environmental policies. In general, these policies require creation and maintenance of conditions under which human activities and natural environments can exist in productive harmony including preservation of historic and archeological resources. Deep-draft navigation projects are documented by a series of studies, each more specific than the previous one. The series of reports produced for a given type of project varies by Corps Division and by the date of the project (due to changing regulations). However, in general, an initial evaluation (or reconnaissance) report and a feasibility (or survey) report are prepared prior to Congressional project authorization. (Refer to ER 1105-2-10 for a description of this process.) Environmental studies are included in an overall framework of engineering, economic, and other types of analyses (ER 1105-2-50).

b. Statutes and Regulations. Compliance with Federal statutes, executive guidelines, and Corps regulations often requires studies of existing environmental conditions and projections of conditions likely to occur in the future with and without various activities. Table 2-1 lists the major environmental statutes and regulations that are currently applicable to Corps deep-draft navigation projects. Three statutes that have a major impact on the planning and operation of deep-draft navigation projects are: The National Environmental Policy Act, The Clean Water Act, and The Marine Protection, Research and Sanctuaries Act.

(1) National Environmental Policy Act (NEPA). NEPA is the Federal statute that established national policy for the protection of the environment and set goals to be achieved along with the means to carry out these goals. For deep-draft navigation projects, including operation and maintenance, where significant effects upon the human environment are expected, an Environmental Impact Statement (EIS), in accordance with US Environmental Protection Agency (EPA) implementing regulations for NEPA (40 CFR 220-229), will normally be required. An Environmental Assessment (EA), in lieu of an EIS, may be a sufficient means to evaluate the impacts of certain navigation-related activities which would have no significant impact on the environment. (ER 200-2-2 provides detailed guidance.)

(2) Clean Water Act. Section 404 of the Clean Water Act governs the discharge of dredged or fill material into waters of the United States. The evaluation of the effects of discharge of dredged or fill material should include consideration of the guidelines developed by EPA (40 CFR 230) in accordance with the requirements of Section 404(b)(1). These requirements include an evaluation of disposal alternatives; a determination that the proposed discharge will not result in an unacceptable degradation of the physical, biological, and chemical integrity of the waters of the United States; and consideration of those factors in Sections 403(c)(1) and 404(c). See paragraph 5-6 of this manual and 33 CFR 209.145 for additional details.



29 May 87

Table 2-1. Environmental Protection Statutes and Other  
Environmental Requirements

---

Federal Statutes

Clean Air Act, as amended, 42 U.S.C. 7401, et seq.

Clean Water Act, as amended (Federal Water Pollution Control Act), 33 U.S.C. 1344, et seq.

Coastal Zone Management Act of 1972, as amended, 16 U.S.C. 1451, et seq.

Deep Water Port Act of 1974, as amended, 33 U.S.C. 1501, et seq.

Endangered Species Act, as amended, 16 U.S.C. 1531, et seq.

Estuary Protection Act, 16 U.S.C. 1221, et seq.

Federal Water Project Recreation Act, as amended, 16 U.S.C. 668aa-668ee, et seq.

Fish and Wildlife Coordination Act, as amended, 16 U.S.C. 661, et seq.

Historic Site Act of 1935, as amended, 16 U.S.C. 461, et seq.

Land and Water Conservation Fund Act, as amended, 16 U.S.C. 4601-4601-11, et seq.

Marine Protection, Research and Sanctuaries Act of 1972, 33 U.S.C. 1401, et seq.

National Environmental Policy Act of 1969, as amended, 42 U.S.C. 4321, et seq.

National Historic Preservation Act of 1966, as amended, 16 U.S.C. 470, et seq.

Preservation of Historic and Archaeological Data Act of 1974, as amended, 16 U.S.C. 469, et seq.

River and Harbor Act, 3 March 1899, 30 stat. 1151, 33 U.S.C. 401 and 403, and 30 stat. 1152, 33 U.S.C. 407, et seq.

Watershed Protection and Flood Prevention Act, 16 U.S.C. 1001, et seq.

Wild and Scenic Rivers Act of 1968, as amended, 16 U.S.C. 1271, et seq.

Executive Orders, Memoranda, etc.

Protection and Enhancement of Cultural Environment (E.O. 11593)

(Continued)

Table 2-1 (Continued)

---

Executive Orders, Memoranda, etc.

Floodplain Management (E.O. 11988)

Protection of Wetlands (E.O. 11990)

Protection and Enhancement of Environmental Quality (E.O. 11991)

Environmental Effects Abroad of Major Federal Actions (E.O. 12114)

Analysis of Impacts on Prime and Unique Farmlands (CEQ Memorandum, 11 Aug 80)

Interagency Consultation to Avoid or Mitigate Adverse Effects on Rivers in the  
Nationwide Inventory (CEQ Memorandum, 11 Aug 80)

Guidance on Applying Section 404(r) of the Clean Water Act to Federal Projects  
Which Involve the Discharge of Dredged or Fill Materials into Waters of the  
U. S. Including Wetlands (CEQ Memorandum, 17 Nov 80)

Agency Regulations

Corps of Engineers

Policy and Procedures for Implementing NEPA	(ER 200-2-2)
Planning Programs	(ER 1105-2-10)
Project Planning	(EP 1105-2-15)
General Planning Principles	(ER 1105-2-30)
Environmental Resources	(ER 1105-2-50)
Recreation-Resource Management of Civil Works Water Resource Projects (Changes 1 thru 4, 28 May 71) (Under Revision, DAEN-CWO-R)	(ER 1130-2-400)
Lake Shore Management at Civil Works Projects	(ER 1130-2-406)
Corps of Engineers Participation in Improvements for Environmental Quality, 30 Apr 80	(ER 1165-2-28)

(Continued)

Table 2-1. (Concluded)

---

Agency Regulations (Continued)

US Environmental Protection Agency

Ocean Dumping Regulations and Criteria (40 CFR 220-229)

Guidelines for Specification of Disposal Sites for  
Dredged or Fill Material (40 CFR 230)

Council on Environmental Quality (33 CFR 209.145)

Regulations for Implementing the Procedural Provisions  
of the National Environmental Policy Act of 1969 (40 CFR 1500-1508)

(3) The Marine Protection, Research and Sanctuaries Act (MPRSA). The MPRSA governs the transport of dredged material for the purpose of ocean disposal. Title I of the MPRSA, which is the Act's primary regulatory section, authorizes the Secretary of the Army acting through the Corps (Section 103) to establish ocean disposal permit programs for dredged materials. In addition, Section 103(e) requires that Federal projects involving ocean disposal of dredged material shall meet the same requirements as developed for permits. Title I also requires EPA to establish criteria (40 CFR 220-229), based on those factors listed in Section 102(a), that provide the basis for evaluating permit actions and Federal projects. Further, Section 102(c) of Title I authorizes EPA to designate recommended ocean disposal sites and/or times for dumping of nondredged and dredged material. In the evaluation of Federal projects, major consideration must be given to assessing the effects of ocean disposal of dredged material on human health, welfare, or amenities, or the marine environmental, ecological, or economic potentialities. As part of this evaluation, consideration must be given to utilizing, to the extent feasible, ocean disposal sites designated by the EPA. (Refer to paragraphs 5-2 and 5-3 of this manual and 33 CFR 209.145 for additional details.)

c. Environmental Study Management. At each stage of a project, efforts should be made to identify key environmental concerns and corresponding future information needs. Forecasting of data needs is necessary in order to schedule adequate time and funding for field data collection, physical or numerical modeling, etc. Scheduling work by others should allow time and funds for administrative procedures such as contractor selection, contract management, review procedures, and potential delays.

(1) Critical issues. Time and money constraints preclude detailed investigations and data collection for every area of interest; therefore, the most critical issues should be identified. It is essential that the number of factors assessed be adequate to fully account for all significant effects. However, increases in the numbers of factors will increase the time, funds, and expertise required for study. Therefore, a proper balance between adequate analysis and study resources must be achieved. Criteria for determining the importance of an issue include, but are not limited to, statutory requirements, executive orders, agency policies and goals, and public interest.

(2) Environmental data. Methodology for environmental data collection is discussed in greater detail in Chapter 5 of this manual. Each investigation must be designed with well-defined, detailed objectives prior to data collection. Investigation design should include a rationale for hypotheses to be tested, variable selection, sampling locations and frequencies, and data storage and analysis.

(a) Environmental studies during the preliminary stages of project development should emphasize identification of resources, development of an evaluation framework, and collection of readily available information for all potential alternatives. Resources likely to be impacted are investigated, and further information needs are identified.

(b) Detailed analysis normally occurs after two or three specific alternatives have been selected for further study. Major emphasis of environmental studies in the detailed assessment stage should be directed toward

29 May 87

identifying, describing, and appraising individual effects and evaluating the net effects of each alternative. Both positive and negative environmental effects should be characterized in adequate detail so they can be used along with the economic and technical analyses to compare alternatives.

## 2-2. Hydraulic Design Aspects.

a. General. This section has been included to provide the user with an overview of hydraulic considerations for deep-draft projects. The user should refer to EM 1110-2-1613 for more detailed guidance on hydraulic design for deep-draft projects. The following factors are major considerations in the hydraulic design of deep-draft waterways: the amount, size, and type of traffic that will be using the waterway; commodities moved; safety; efficiency; reliability; and cost. Safe use of the project should receive primary consideration before the project is optimized with respect to cost. Safety will depend upon vessel size and maneuverability, size and type of channel, effects of currents and wind, placement and condition of navigational aids, and experience and judgment of the pilots (Figure 2-1).

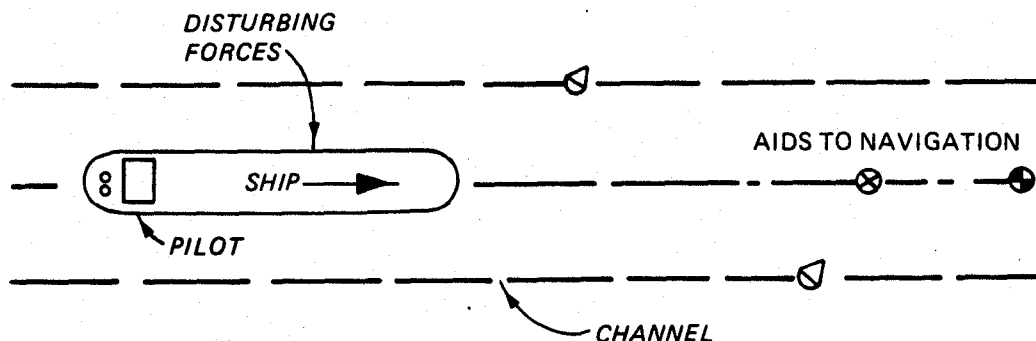

- PILOTING ASPECTS  
SKILL, DILIGENCE, TRAINING, KNOWLEDGE
- NAVIGATION/INFORMATION AIDS  
ACCURACY, RADAR AND DECCA, METEO/HYDRO
- ENVIRONMENTAL FACTORS  
WIND, WAVE, CURRENT, VISIBILITY, TRAFFIC
- CHANNEL PROPERTIES  
TYPE, LAYOUT, CRITICAL MANEUVERS

Figure 2-1. Factors influencing channel dimension

b. Channel Design Data Requirements. Data to be collected prior to design of navigation channels include maximum and minimum water levels and frequency, duration, and amplitude of water-level fluctuations. Tidal data are required to determine the appropriate water-level data for waterways influenced by tides. Estimates of wind, waves, and currents are needed to determine their effects on vessel motions and controllability. Estimates of the rates of sediment erosion and deposition, extent and characteristics of salinity intrusion, and flushing characteristics are also usually needed.

c. Design Vessel. Before initiating design of a navigation channel, a design vessel must be selected. The projected vessel fleet over the economic

29 May 87

life of the project will be an aid in selecting characteristics of the design vessel. The amount of traffic will determine if one-way or two-way traffic should be provided. Layouts of the various channel dimensions and alignment plans to accommodate the design vessel should be evaluated on the basis of tonnage, trip time, safety, environmental and social impacts, and construction and maintenance costs.

d. Channel Alignment. After the design vessel has been selected, the channel alignment and dimensions must be optimized. The alignment of a navigation channel is usually designed to follow the course of the deepest channel in a river or estuary. This is done in order to minimize initial and maintenance dredging. Bends in the alignment should be minimized as much as possible, and where gradual bends are not practical, cutoffs should be considered. Channel alignment studies should consist of selecting several alternate routes and estimating construction and maintenance costs for each. An optimum channel alignment is determined according to a comparison of annual project costs and benefits, assuming there are no overriding cultural or environmental constraints.

e. Channel Depth. Channels of limited depth can affect ship maneuverability because of the turbulent flow pattern produced. In shallow water, vessels become harder to handle and require large rudder angles to maneuver. Shallow-water operations require greater power and use more fuel than operations in deep water. The design channel depth should be adequate to accommodate the deepest draft vessel expected to use the waterway, although if the deepest draft vessel rarely uses the channel, it may be economic to expect the vessel to transit only at higher water stages. The design depth should be selected after comparing the cost of vessel delays, operation, and light loading with the construction and maintenance cost involved as well as the associated net economic benefits of each size of channel considered in the project investigation. The required depth is the total of the following factors: design vessel loaded draft, squat, sinkage in fresh water, effect of trim and wave action, and safety efficiency clearance. Figure 2-2 depicts depth determination factors. Refer to EM 1110-2-1613 for detailed design information.

f. Channel Width. Channel widths should be designed to provide for the safe and efficient movement of the vessels expected to use the channel. The minimum channel width will depend on the size and maneuverability of the vessels, channel shape and alignment, traffic congestion, wind, waves, currents, visibility, quality and spacing of navigation aids, and whether one-way or two-way traffic is allowed. Guidelines for estimating approximate channel width are shown in EM 1110-2-1613. Channel widths have to provide for the width of the maneuvering lane, clearances between vessels when passing, and bank clearances. Elements that should be included in computing total channel width are shown in Figure 2-3. The maneuvering lane is that portion of the channel width within which the vessel might deviate from a straight line without encroaching on the safe bank clearance or on the path of another vessel. Maneuvering lanes must be separated to provide safety clearance for channels designed for two-way traffic in order to avoid interference and danger of collision. Bank clearance is required to reduce or eliminate both the danger of hitting the bank or grounding and the effect of bank suction on the controllability of the vessel. A wider maneuvering lane will be required in bends since the path of a vessel making a turn is wider than its path in a straight reach. The width of the

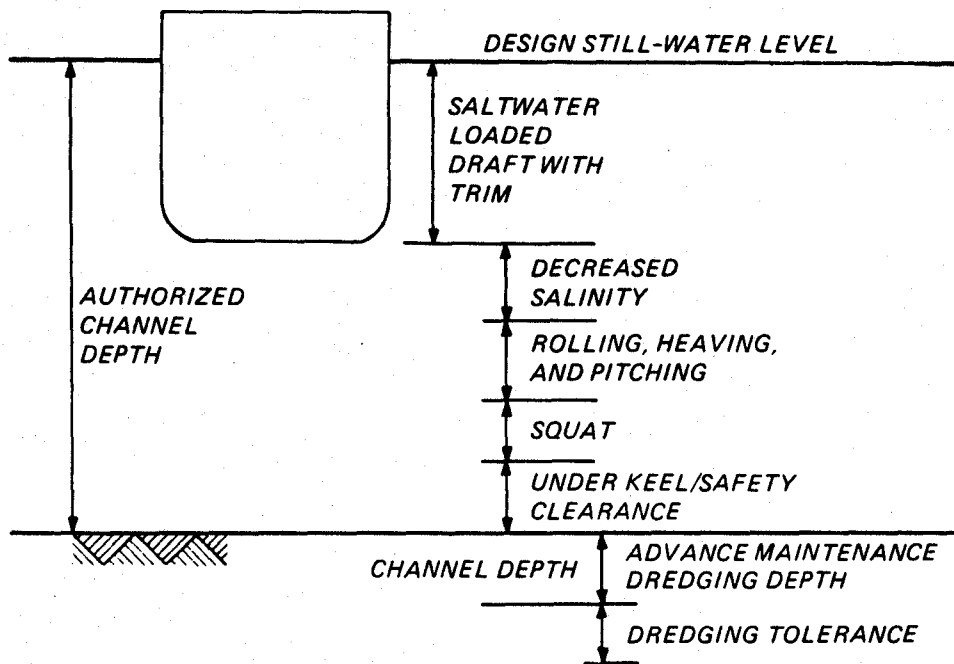

Figure 2-2. Factors affecting required channel depth

path will depend on the amount of turn, speed and maneuverability of the vessel, length and beam of the vessel, and effects of waves and current.

g. Project Maintenance. In estuaries and lakes, channel dimensions are normally maintained by dredging, although training structures such as rock jetties are also commonly used to exclude littoral drift sediments from harbor entrances and to stabilize the channel location. In rivers, channel dimensions are also maintained by dredging, but training works such as pile dikes (Lower Columbia) or articulated concrete mattresses (Lower Mississippi) may be helpful as well.

h. Ship-Generated Waves. Moving ships generate waves that can pose a hazard to pleasure craft, cause bank erosion, and affect the stability of shoreline structures. The effects of waves will depend on the height of the generated wave and the distance between the ship and the smaller boats or shoreline. Mitigation measures may be required if ship waves are higher than those naturally occurring from wind or ocean swell or those created by pleasure craft. The two most common mitigation measures are reduced speeds and shore protection. In some cases, it may be practical to locate the navigation channel a sufficient distance from the shore so that the waves reaching the shore will not be destructive.

i. Miscellaneous. Other items that require engineering study include turning basins, jetties, control or training structures, shore protection, entrance channels, obstructions such as bridge piers, and aids to navigation.

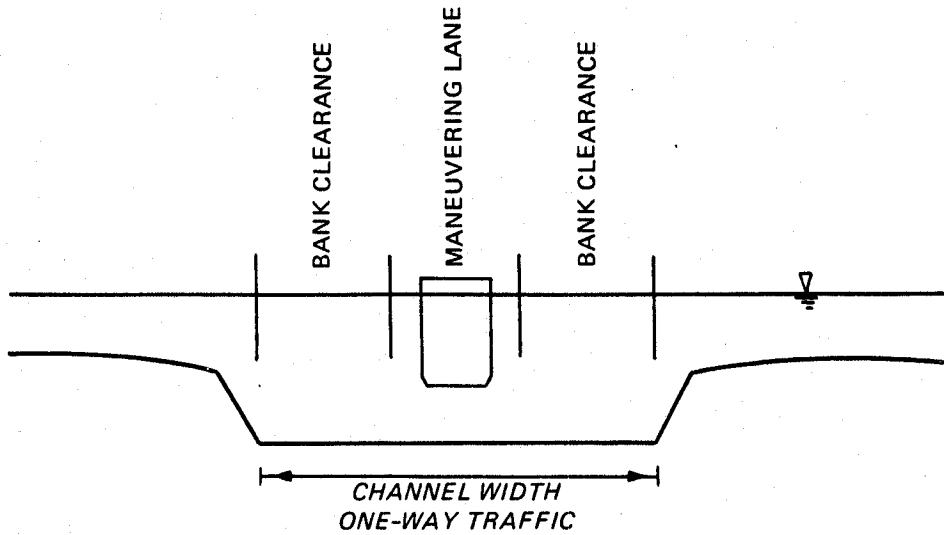

a. One-way traffic

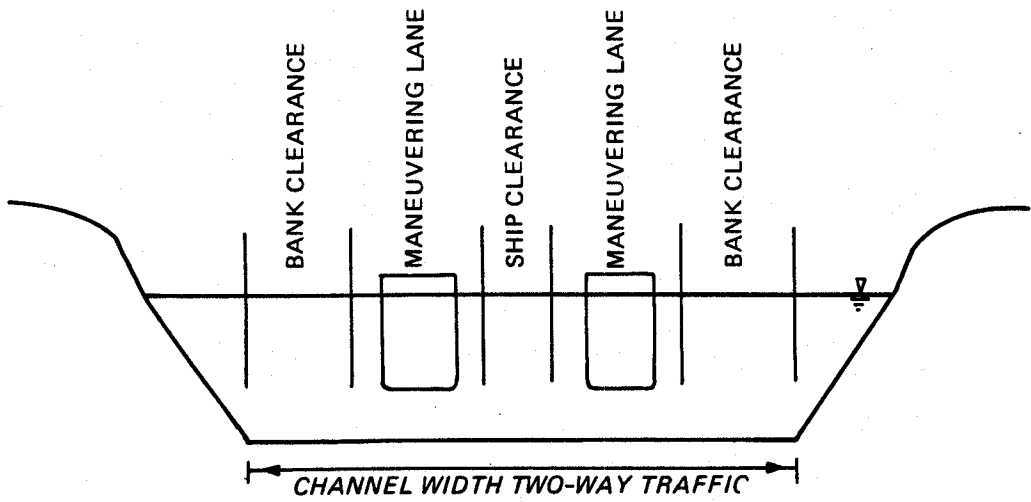

b. Two-way traffic

Figure 2-3. Channel width elements



29 May 87

### 2-3. Water Quality Considerations.

a. General. Water quality considerations for addressing potential impacts of deep-draft navigation projects can be categorized as follows:

- (1) Dredging and disposal during construction and maintenance.
- (2) Increased pollutant loadings due to facility construction, vessel discharges, and accidental spills.
- (3) Altered or absence of circulation due to changes in geometry.
- (4) Salinity changes.

Industrial and municipal effluents and agricultural runoff with attendant problems of low dissolved oxygen (DO), eutrophication, or toxic contamination are not a primary Corps concern unless Corps activities have the potential to mitigate or intensify already existing water quality problems. However, these conditions and the potential for water quality problems should be identified and documented in the early project stages.

b. Dredging and Disposal. In general, adverse water quality impacts directly attributable to the release of chemical substances into the water column by dredging activities are minimal. Procedures are available for evaluating the environmental impacts of the three major disposal alternatives: open-water, intertidal, and upland methods (see paragraphs 3-5 and 4-1). Water quality considerations for dredging and disposal operations are summarized in the DMRP Synthesis Report Series. An index of these related reports is given in WES TR DS-78-23 (Herner and Company 1980). For detailed information on water quality considerations during dredging, refer to EM 1110-2-5025.

c. Pollutant Loadings. Deep-draft navigation projects can stimulate the construction of associated anchorage, loading, storage, and related facilities. Associated with industrial development are possible industrial effluents, spills, and surface runoff contamination. Increased waterborne traffic increases the possibility of vessel discharges and accidental spills.

d. Altered Circulation.

(1) Circulation may be altered as a result of changes in channel geometry and bottom topography caused by dredging and dredged material disposal. Changes in circulation may result in changes in the spatial distribution of water quality constituents, changes in the flushing rates of contaminants, and changes in the pattern of scour and deposition of sediments.

(2) Environmental assessment of the effects of changes in circulation should initially emphasize the physical parameters such as salinity, temperature, and velocity and their impacts on plant and animal communities. These initial analyses should consider changes in vertical stratification when deepening of a channel is proposed. Increased density stratification inhibits vertical mixing, which may result in depletion of DO in bottom waters. If minimal changes occur in these parameters, then it can be generally assumed that the chemical characteristics of the system will not change significantly. This

29 May 87

approach is based on a methodology that permits assessment without requiring extensive data and knowledge of the processes affecting the water quality constituent of direct interest. However, this approach is invalid if preliminary water quality surveys indicate the existence of toxic constituents at concentrations potentially damaging to biotic populations. Prediction of change in circulation and its effect on the physical parameters can be achieved through comparison with existing projects, physical model studies, and numerical simulation. Additional information on water quality considerations is provided in paragraph 5-2.

#### 2-4. Biological Considerations.

a. General. The effects of deep-draft waterways on plants and animals result from physical changes in habitat due to the enlargement of channels, disposal of dredged material; and construction of associated locks and dams, revetments, breakwaters, jetties, and navigation aids. Other effects may result from changes in contaminant levels, turbidity, suspended sediments, salinity, circulation, and erosion. Preliminary research suggests that navigation traffic itself affects certain species.

b. Physical Change in Habitat. Short- and long-term habitat effects may result from deep-draft waterway construction activities.

(1) Short-term effects include the burial and disturbance of the organisms in the vicinity of the activity. Fish, birds, and other mobile organisms can leave the area while less mobile biota, such as benthic invertebrates and rooted plants, are buried. Since many aquatic organisms recolonize rapidly, the primary concern for short-term effects is the loss of environmentally sensitive species, coral reef species, and commercially or recreationally important species such as clams, oysters, and mussels. In addition, long-lived species such as mussels may be slow to recover from a physical impact and may require additional consideration in the impact study. When endangered or threatened species are present, the Corps must implement Section 7 of the Endangered Species Act.

(2) Long-term effects are changes in habitats, including changes in depth, substrate particle size (e.g. sand to mud, or sand to rock structure), chemical constituents (e.g. nutrients and contaminants), and flows (e.g. direction and magnitude of current). Along with these changes, an associated change in organisms that use these habitats also occurs. The more mobile organisms may relocate to other areas if the affected areas become unsuitable. The more sedentary organisms, such as marine worms, clams, and other benthic invertebrates, may either recolonize the habitat or, if changed, be replaced by organisms suited to the new habitat. Some of the habitats are finite and their loss would be a major concern. Such habitats may include spawning areas for fish, coral reefs, oyster reefs, wetlands, or feeding areas for birds. Another consequence can be increased species diversity from increased habitat diversity. The area must also be evaluated in the early project stages to determine if it has been designated as critical habitat for endangered species.

(3) Secondary effects such as a change in benthic species size or depth occupied below the sediment surface may change their suitability or availability as food to predators.

29 May 87

c. Contaminants. Changes in contaminant levels may be caused by dredging activities, construction activities, vessel discharges and spills, prop wash, and circulation pattern alterations. Contaminants pose a potential hazard to aquatic life. They may cause mortality or chronic effects if the contaminants, when persistent and present in a bioavailable form, are taken up by organisms. This may be particularly significant if highly contaminated areas are to be disturbed by the project activities.

d. Turbidity/Suspended Solids. Activities that can be responsible for generating increased turbidity and suspended solids are vessel movements, prop wash, change in circulation, erosion, and dredging and disposal of dredged material.

(1) Resuspension of bottom sediment in the wake of large ships, tugboats, and tows can be considerable. For example, each year shrimp trawlers in Corpus Christi Bay, Texas, suspended 16 to 131 times the amount of sediment that is dredged annually from the main ship channel. In addition, suspended solids levels of 0.1 to 0.5 parts per thousand (ppt) generated behind the trawlers are comparable to those levels measured in the turbidity plumes around open-water pipeline disposal operations. In fact, where bottom clearance is 3 feet or less, a scour depth of up to 3 feet may occur in easily suspended sediments.

(2) Research results from the DMRP indicate that the traditional fears of water quality degradation resulting from the resuspension of dredged material during dredging and disposal operations are for the most part unfounded. The possible impact of depressed levels of DO has also been of some concern, due to the very high oxygen demand associated with fine-grained dredged material slurry. However, even at open-water pipeline disposal operations where the DO decrease should theoretically be greatest, near-surface DO levels of 8 to 9 parts per million (ppm) will be depressed during the operation by only 2 to 3 ppm at distances of 75 to 150 feet from the discharge point. The degree of oxygen depletion generally increases with depth and increasing concentration of total suspended solids; near-bottom levels may be less than 2 ppm. However, DO levels usually increase with increasing distance from the discharge point, due to dilution and settling of the suspended material.

(3) It has been demonstrated that elevated suspended solids concentrations are generally confined to the immediate vicinity of the dredge and discharge point, and dissipate rapidly at the completion of the operation. If turbidity is used as a basis for evaluating the environmental impact of a dredging or disposal operation, it is essential that the predicted turbidity levels be evaluated in light of background conditions. Average turbidity levels as well as the occasional relatively high levels that are often associated with naturally occurring storms, high wave conditions, and floods should be considered.

(4) Fluid mud (or fluff) is a special case involving high concentrations of suspended sediments. It can occur during open-water disposal of hydraulically dredged, fine-grained material having a high water content. Fluid mud creates a layer of low DO and unstable substrate for bottom-dwelling organisms.

(5) Clam or oyster beds, coral reefs, highly productive areas, and other sensitive habitats have the potential for the greatest effect from turbidity and suspended solids. The presence of these areas in the project area should be determined, and special turbidity control measures should be used to protect these areas from the impacts of project activities (refer to WES TR DS-78-13).

(6) Potential impacts of elevated suspended sediment concentrations on egg and larval stages of fishes have been identified as a primary concern by resource management agencies. Egg and larval forms, due to their essential dependence on local hydrodynamic conditions for transport into and out of project areas and their limited or lacking avoidance capabilities, are considered to be more susceptible to detrimental effects than motile juvenile and adult life history stages (Lunz et al. 1984a,b). Two basic reproductive patterns by fishes generate different types of concern in relation to dredging operations. Many estuarine-dependent species produce pelagic (free floating, unattached) eggs which, depending on their densities, may occur at various levels in the water column from surface to bottom. Potential impacts on pelagic eggs are therefore related to both spatial distributions of suspended sediments and duration of exposure at specific concentrations. Other fish species produce demersal, nonbuoyant eggs which may adhere to substrate and remain in place for short to extended periods of time prior to larval hatching and release. In addition to the problem of exposure duration, demersal eggs may be subject to burial by accumulated deposited sediments. The actual causal factors by which suspended sediments affect eggs and larval fishes are complex and little understood. Some of these factors are mechanical abrasion of egg and larval surficial membranes, reduction of available light in the water column, and sorption of contaminants carried by the sediments. Very little is known of the importance, if any, of synergistic effects resulting from combinations of causal factors, or of physical features of the suspended particles such as size or angularity. Stresses of chemical, physical, or biological nature may be manifested in chronic rather than acute effects. Indirect effects of elevated suspended sediments may be of consequence, for example through interference with feeding behavior of visually oriented larvae, or delayed development resulting in asynchronous occurrences of larvae and their prey. There is some indication that larval stages are more sensitive than egg stages. In light of current knowledge of spatial extent of suspended sediment concentrations associated with dredging operations, and in consideration of expected durations of exposure of eggs and larvae in project areas, there is no evidence that dredging operations (assuming no contaminants are present) adversely impact fish egg or larval stages with the exception of the occurrence of demersal eggs within 500 yards of the dredge location.

(7) In contrast to the data for fish eggs and larvae, data for oyster eggs and larvae showed greater effects to natural sediment suspensions (Lunz et al. 1984a, b). Special consideration should therefore be given to proximity of productive oyster reef or other shellfish beds to proposed dredging operations. Designation of a "buffer zone" should take into account individual site characteristics such as currents and circulation, as well as material composition and other characteristics.

(8) Insofar as direct physical effects of elevated suspended sediment concentrations on juvenile fish stages are concerned, the literature is sparse and incomplete (Lunz et al. 1984a, b). Insufficient evidence is

29 May 87

available which to base assertions that dredging operations involving uncontaminated sediments pose either real or insignificant physical threats to juvenile fishes or shellfishes. Consideration should therefore be given to both scale and location of proposed dredging operations on a case-by-case basis, but restrictions based solely on seasonal concerns alone appear justified.

(9) Some additional concern is warranted with regard to sessile forms to estuarine and coastal invertebrates (Lunz et al. 1984a, b). Sessile or other forms having very limited powers of locomotion can be assumed to be susceptible to long-term exposures of elevated suspended sediment concentrations in the immediate vicinity of dredging operations. Most shellfishes adapted to naturally turbid estuarine conditions have adequate mechanisms, exemplified by valve closure or reduced pumping activity or oysters, to compensate for short-term exposures. There is insufficient technical information upon which to establish conclusive relationships between dredging-related turbidity fields and significant impacts on adult and subadult shellfishes. "Buffer zones" around operating dredges should be determined on a case-by-case basis, taking into account the resources at the site, as well as site and material characteristics.

(10) There are two fundamental areas of concern related to subadult and adult fish: (a) elevated concentrations of suspended sediments have detrimental effects on adult and subadult fishes; and (b) turbidity fields constitute a barrier to migratory patterns of sensitive species, especially anadromous salmonids, herrings, striped bass, and others (Lunz et al. 1984a, b). The latter concern is by far the more difficult to address. The supposition that a given species will not cross or circumvent a turbidity field can be substantiated or refuted only by properly designed field studies. There is no known existing data which conclusively demonstrate behavioral responses of a negative positive, or indifferent nature on the part of target species to the presence of turbidity field or plumes. However, significant evidence supports the fact that adult and subadult stages are moderately to extremely tolerant of elevated suspended sediment concentrations. Given that the level of suspended sediment surrounding a dredging activity seldom exceeds 1,000 milligrams per liter, and this level is confined to a relatively small areal extent, there is no justification to predict significant dredge-induced physical effects on adult estuarine fishes. Additionally, there is no justification to suspect that these highly mobile organisms would be subjected to dredge-produced elevated suspended sediment levels for sufficient periods of time to incur even sublethal adverse effects. Possible exceptions include dredging operations handling contaminated sediments, or sediments consisting primarily of highly angular particles that could abrade the fishes' gills or other sensitive membranes.

e. Salinity. Changes in salinity may result from changes in circulation patterns resulting from channel enlargement, structures, and navigation traffic.

(1) Salinity has a major effect on specific composition, especially on lower food web components, including microalgae, emergent vegetation, plankton, and bottom-dwelling organisms. Salinity also determines fish distributions. As it affects flood distribution (prey), it also affects bird and fish feeding locations.

29 May 87

(2) The effect of a change in salinity on a given organism is dependent on its sensitivity to saline water. Juvenile marine fish are often more tolerant of lower salinities and generally are found in the shallow, less saline bays or further upriver, while adults of these species may be confined to deeper channels or may not enter the estuary. Free-moving animals such as fish can adjust their movements to the change in salinity, which may in turn change utilization of feeding, resting, and spawning habitats. Nonmobile organisms sensitive to the change will be replaced by biota more tolerant of the new salinity. Again, this is dependent on the magnitude and rate of the salinity change with reference to a species tolerance range and will generally be determined by tidal and seasonal minimum salinity.

f. Circulation. Channel deepening and navigation structures may change circulation and flushing conditions, which influence movement patterns of floating and free-swimming plants and animals within rivers, lakes, estuaries, and embayments and between coastal bodies of water and the ocean. These movement patterns influence their availability as food to other organisms, utilization of food and spawning areas, and their occupation of a habitat. The movement of sediment, turbid water, fresh water, saltwater, nutrients, and contaminants may be altered by changes in circulation, and in turn may affect the organisms present in the impacted area.

g. Erosion. A change in the rate of erosion may result from channel enlargement, circulation pattern alterations, and navigation traffic increases. Deepening and widening the channel may increase the instability of the channel. An increase in size and number of boats may increase erosion by the prop wash and of shorelines from wave wash. Alteration of water circulation patterns will cause some areas to become depositional while others become erosive.

(1) The stability of a bottom or shoreline has a major effect on the organisms present. Highly erosive areas generally have fewer numbers and species (Figure 2-4). The species will change to those adapted to the unstable conditions.

(2) Many other erosive forces may mask or confound the effects of project-associated erosion (for example, wind- versus vessel-induced waves).

h. Navigation Traffic. The impacts of navigation traffic on biota have been debated for a number of years; however, at present there is a scarcity of documentation concerning actual observed biological impacts resulting from navigation traffic. Ship passage can cause the suspension of some bottom-dwelling macroinvertebrates. Resuspension of sediments by navigation traffic is also of concern since (Figure 2-5): (1) increased suspended solids result in decreased primary productivity; (2) ships may resuspend and redistribute sediment particles, transporting them in a lateral direction, resulting in increased deposition in shallow waters, backwaters, and secondary channels; and (3) increased sedimentation might result in the "smothering" of benthic organisms and destruction of fish spawning areas, oyster beds and coral reefs. Of the various possible biological impacts from navigation traffic, one having the greatest potential impact would be wave and drawdown disturbance on littoral (shoreline) shallow water and/or backwater areas. Such habitats are important since they serve as nursery areas for larval and young-of-the-year fish and support highly productive macroinvertebrate and plankton communities.

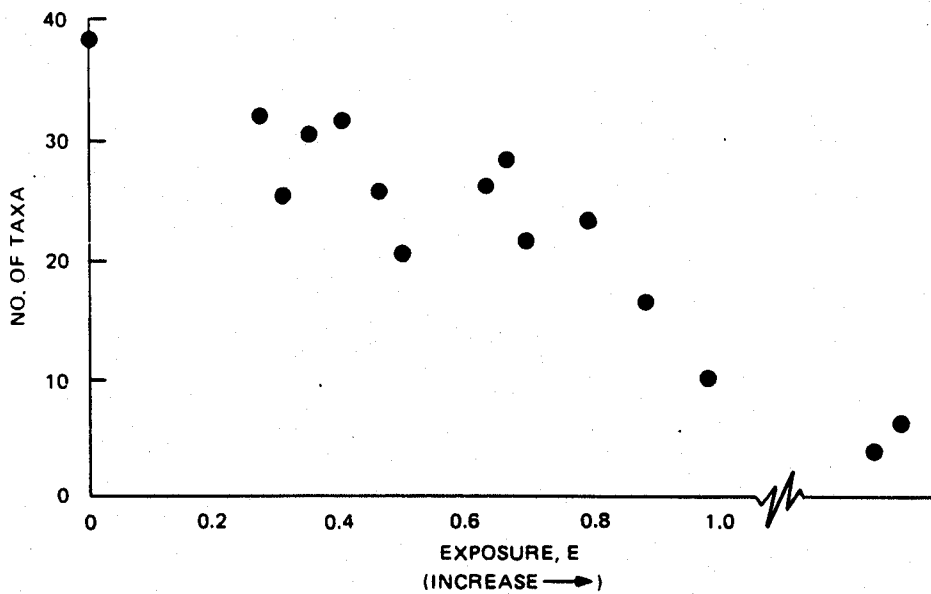
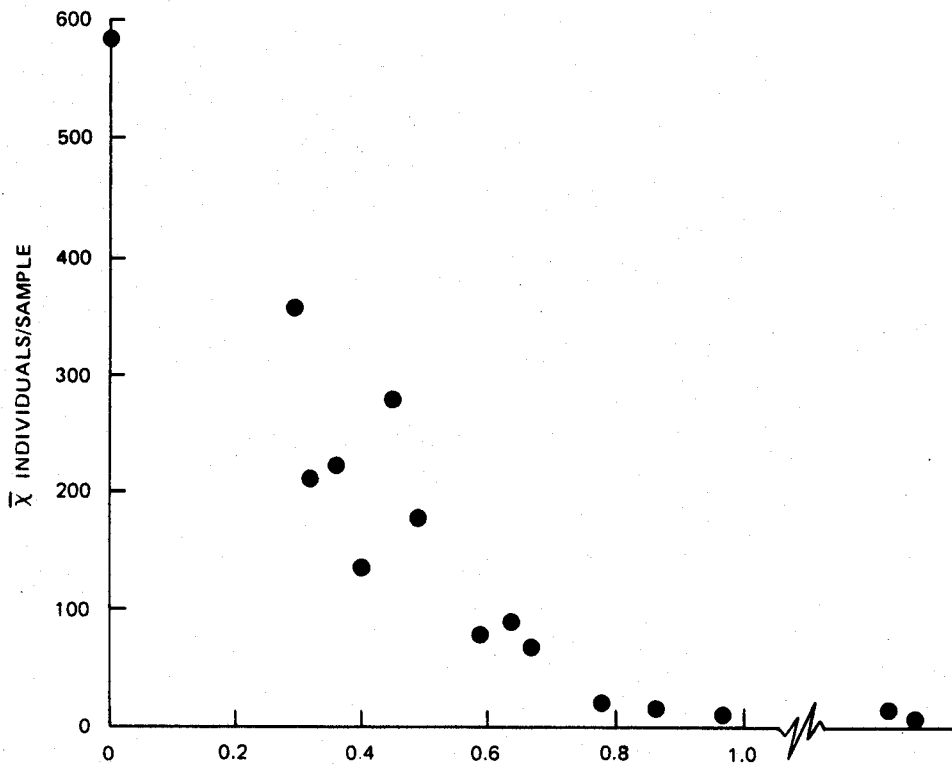

Figure 2-4. Relationship between exposure to wave action and total benthos and number of taxa,  $E = \log(1 + fwd^{-2})$ , where  $f$  = fetch,  $w$  = fraction of time wind blew toward station, and  $d$  = depth of station

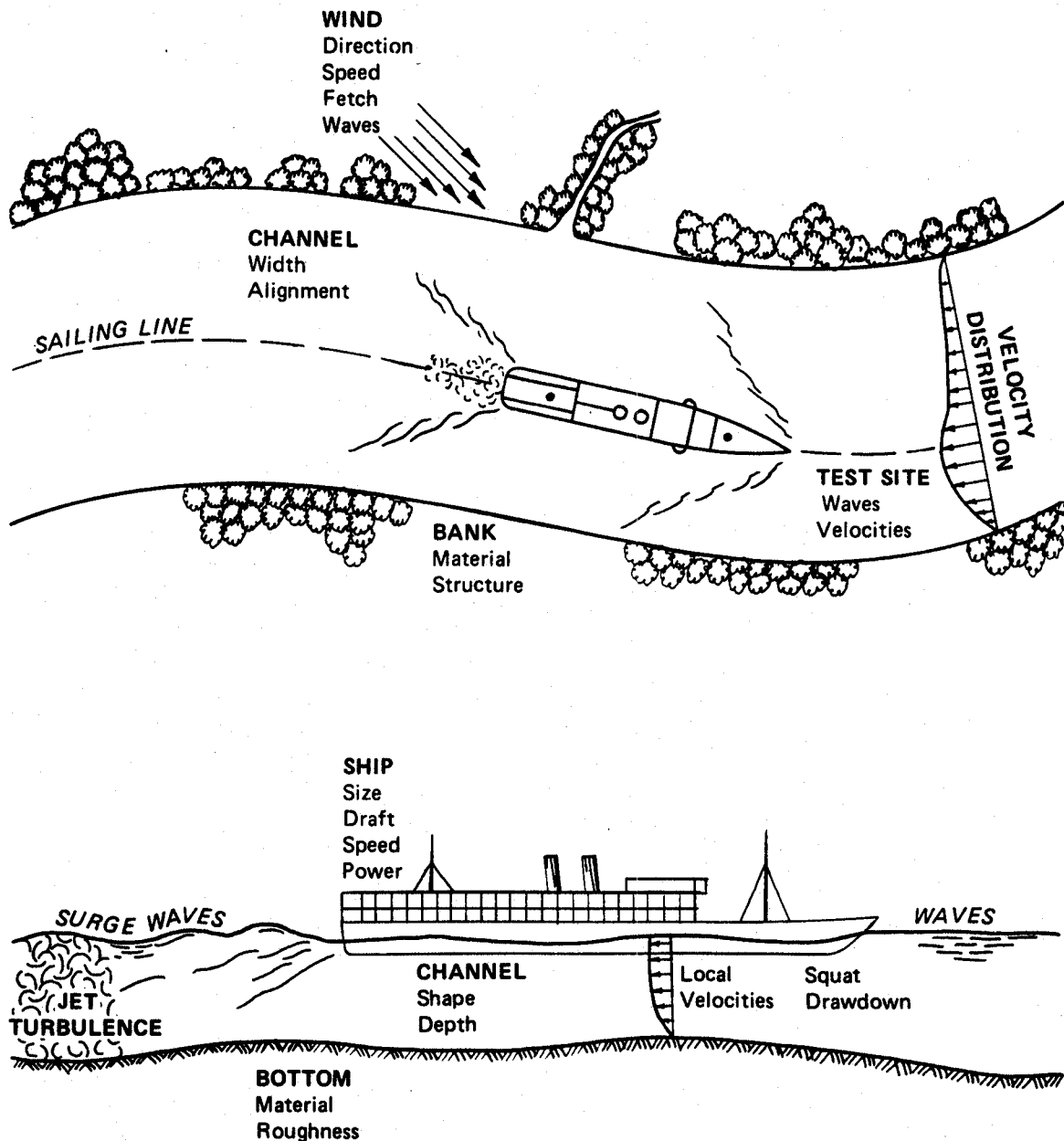

Figure 2-5. Physical effects of navigation



29 May 87

## 2-5. Recreational Considerations.

a. Basic Requirements. Recreation development requires cost sharings by a local sponsor. Refer to ERs 1165-2-400 and 1105-2-20 for cost sharing policies. Additional basic requirements for recreation developments include:

- (1) Sufficient demand to ensure utilization of the facility.
- (2) Publicly controlled sites, including access routes.
- (3) Justified provisions for prevention of vandalism.

b. Selection of Features. Refer to ER 1105-2-20 and Appendix D of ER 1120-2-400 for a description of the types of recreation facilities eligible for Federal cost sharing. In general, eligible facilities are those not ordinarily provided by private enterprise or on a commercial or self-liquidating basis. In addition to these regulations, feature selection is also controlled by project site characteristics.

(1) Structures. The recreational potential of engineering structures such as bridges and piers is generally limited, although in some cases slight modification of structures may increase their suitability. For example, jetties often provide additional fish habitat and may become popular fishing spots. Provision for access, parking, and public safety can enhance recreational potential. Modifications can be incorporated during the design stage or retrofitted to existing structures.

(2) Lands. Project lands, whether purchased or created through dredged material disposal or accretion, have high and diverse recreation potential. They are especially attractive for shoreline recreation development such as swimming beaches, boat launching ramps, marinas, and fishing piers. When areas are of sufficient size, campgrounds (Figure 2-6), multiple play areas, and trail systems are appropriate. While high-intensity recreational use is generally dependent on facilities development, undeveloped project lands can support activities such as nature study, hunting, and beachcombing if sufficient access is provided. Table 2-2 outlines specific activities and required facilities for recreational use of deep-draft navigation areas.

c. Design of Recreation Features. Refer to ER 1110-2-400 for guidance on design of recreation features. Additional information regarding land-based recreation and water-based activities suitable for riverine settings is given by Hynson et al. (1983) and Nunnally and Shields (1983).

d. Carrying Capacity. Recreation facilities should be sized and located to avoid overutilization or underutilization, as well as conflicts with other uses such as navigation. Refer to WES IR R-80-1 (reference 43) for methods to estimate carrying capacity. Overuse often results in degradation of the recreational resource.

## 2.6. Aesthetics.

a. General. Deep-draft navigation projects affect aesthetic characteristics of the environment through changes caused by construction and



Figure 2-6. Shoreline camping area

Table 2-2. Recreational Activities and Facilities,  
Deep-Draft Navigation Areas

Activities	Facilities
Beachcombing	Beach
Bicycling	Trail or road
Boat launching	Ramp, parking area
Camping	Campground
Fishing	Water access
Hiking	Trail
Hunting	Sufficient area and habitat
Nature study	Natural area
Outdoor games	Multiple play area
Picnicking	Tables, trash receptacles, fireplaces
Sunbathing	Beach
Swimming	Suitable water and shoreline
Sightseeing	Scenic overlook or viewing tower

29 May 87

maintenance activities and by the presence of navigation traffic. The aesthetic value of an environment is determined by the combination of perceptual stimuli inherent in the environment, i.e., the sights, scents, tastes, and sounds and the interaction of these. Visual changes are the major aesthetic effects of deep-draft navigation projects. The visual environment for deep-draft navigation includes terrestrial landscapes, shorelines, open-water channels, and waterways. Relatively remote coastal areas associated with some deep-draft navigation projects offer a high-value aesthetic experience for recreators or others present in the project area.

b. Aesthetic Design. All landscape components possess visual properties such as color, form, line, texture, scale, and spatial character. Color refers to an object's light-reflecting properties; line, to the path followed by the eye when viewing an object (usually evident as the edge or outline of an object); texture, to the aggregation of small forms or color mixtures into a larger pattern; scale, to the proportionate size relationship between an object and its environment; and spatial character, to the object's placement or arrangement in three-dimensional space. All of these properties can be manipulated, to some extent, in project design to increase positive visual effects. Scale may be constrained more than the other properties, however, because of its dependence on object size and the limitations on choice of size for most project features. Examples include the use of natural materials which possess colors, forms, and textures that are more desirable than man-made materials, topographic modification of monotonous landscapes by grading or placement of dredged material, and selection and placement of trees and shrubs to improve color, form, line, texture, and scale (Figure 2-7). Landscape design guidance for confined upland dredged material disposal areas and other large structures is provided in Mann et al. (1975).

c. Visual Contrast Rating (VCR) System. Potential visual impacts of proposed waterway projects or impacts at sites of existing projects can be assessed with a procedure such as the VCR system used by the Bureau of Land Management. Sheppard and Newman (1979) provide detailed instructions for application of a modified version of the VCR process. The evaluation procedure involves use of drawings or photographs of the site landscape with modifications artistically superimposed. Assistance of a landscape architect may be required for preparing these scene simulations. Because of the highly personal nature of reactions to visual stimuli, several independent evaluations may be required to generate reliable results for complex projects, and the assistance of a qualified person experienced in visual impact assessment is recommended. Additional methodologies are reviewed in a special issue of the Coastal Zone Management Journal (1982).

## 2-7. Cultural Resources.

a. General. Federal statutes require identification and protection of significant cultural resources in the project area. Cultural resources are the physical evidence of past and present habitation that can be used to reconstruct or preserve human activity. This evidence consists of structures, sites, artifacts, and objects that may be studied to obtain relevant information (Figure 2-8). Cultural resources found in deep-draft navigation project areas provide physical evidence of how the areas were used for commercial and game fishing, navigation, agriculture, and other activities during historic and

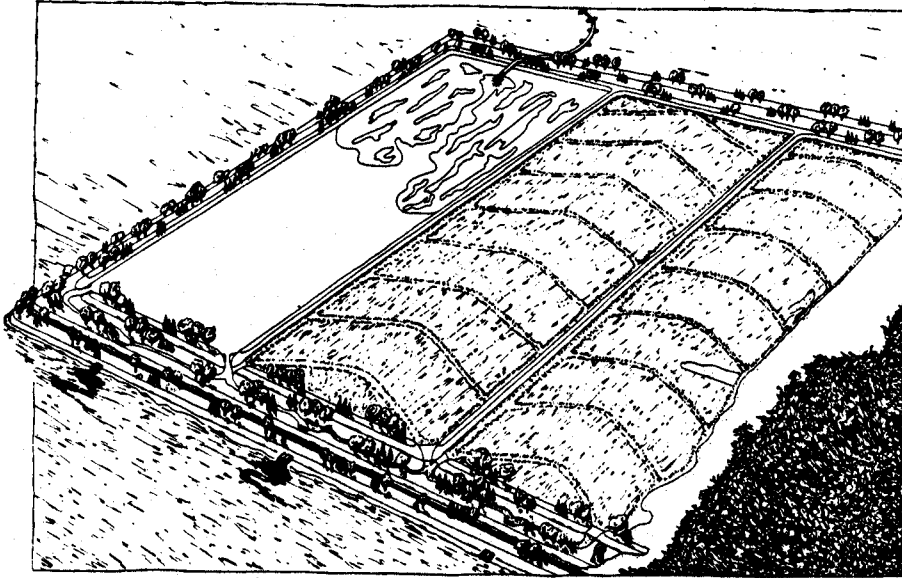

a. Artist's conception of overall appearance of disposal area, showing alteration of disposal operations, interior trenching, and landscaped dikes

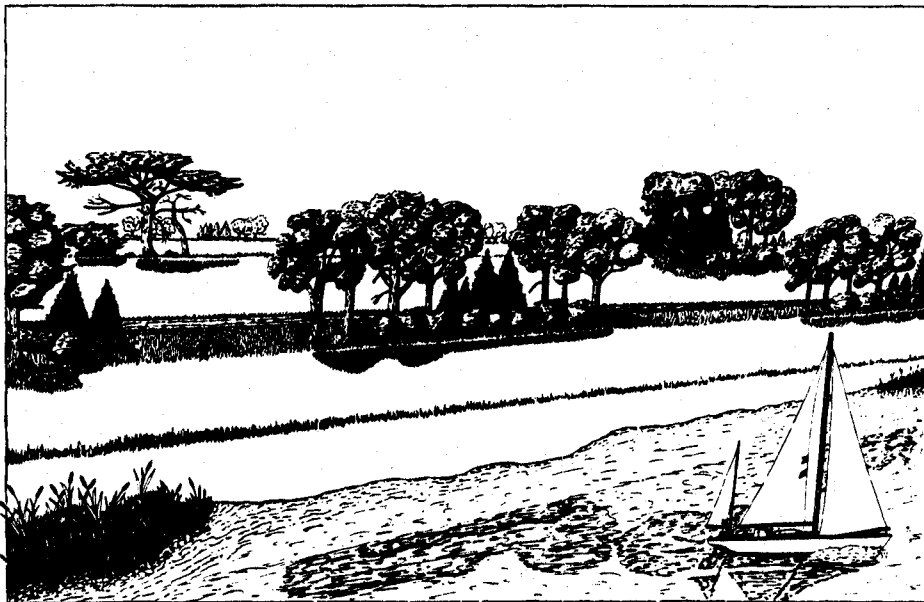

b. Artist's conception of exterior of landscaped dikes from the water level

Figure 2-7. Use of landscaping to modify visual properties of a large diked dredged material disposal area



Figure 2-8. Historically significant vessel

prehistoric periods. Identification and interpretation of cultural resources sites clarify the relationship between present-day use and past use. This information about cultural resources is used in the design phase to ensure that proposed designs will preserve and protect identified cultural resources. For example, disposal areas may be located some distance from the identified sites. This concern for cultural and archaeological resources needs to be pursued during the construction stage. It requires monitoring the dredging and disposal operation and any excavation by observers skilled in archaeological find identification.

b. Cultural Resources Analysis. An analysis of the cultural resources of the project area is usually done during the planning phase to identify sites that require mitigation (which may include preservation measures) due to their cultural significance. An analysis of cultural resources includes an inventory of the cultural resource sites and an assessment of the potential losses or damages due to the project. All activities should be coordinated with the State Historic Preservation Officer (SHPO). Identification of sites is accomplished through interviews with local officials and residents and by examination of archival materials such as the National Register of Historic Places,

29 May 87

National Architectural and Engineering Records, maps, and official records. The interviews and archival search delineate the density of sites and the types of sites present, i.e., prehistoric sites, historic sites, architectural elements, and engineering elements. Cultural resources can also be identified through magnetometer surveys of underwater areas, and from ground surveys of candidate upland disposal sites. The significance of each site is determined based on regional characteristics and professional judgment. Identification and evaluation of a site may require site visits or excavation to verify information. Loss or damage to sites from preliminary or potential project designs can be determined from the inventory and significance analysis.

c. Cultural Resources and Design. Project designers should use the cultural resources analysis to develop designs that incorporate protection of the resources. The protection measures incorporated in designs should be determined based on characteristics of the resource, the project area, and operational and maintenance activities. Cultural sites affected by waves may be stabilized by vegetation or riprap. Physical resources may be excavated and stored. Resources that will be inundated or covered with dredged material or sediment can be removed from the site or stabilized and protected prior to construction, so as to be recoverable later.

## 2-8. Winter Navigation.

a. General. When ice covers a waterway a number of additional environmental considerations come into play. How these are changed by project development and navigation must be addressed in the EIS. Project development can alter ice growth patterns by causing ice to form in new areas and, conversely, causing areas previously covered by ice to remain open. Navigation breaks up the ice allowing it to move; this presents additional problems.

b. Ice Cover Effects. The existence of an ice cover will change the water quality by reducing wave-induced turbidity and hindering gas exchange with the atmosphere. People and animals use the ice cover as a bridge. Many bird species move south when their aquatic food supply is no longer available. The ice cover is used for such recreational activities as snowmobiling, skating, and ice fishing.

c. Navigation Effects. Navigation through an ice cover obviously breaks it up, thereby reducing its value for recreation. But there are many other effects which should be considered. To break and push aside the ice requires higher ship thrust, which results in greater propeller-induced scour. Water drawdown and surge effects along the shoreline are more noticeable. The drawdown can ground the ice. The repeated breaking and churning of the ice accelerates its growth so the ice becomes thicker along the vessel track. One result is a greater blockage of the channel cross section, which in turn alters current directions and speed.

d. Ice Control Measures. There are a number of ice control measures which will mitigate the effects mentioned above. A review of EM 1110-2-1612 will cover these in detail. For example, air bubblers and air screens can minimize ice growth and direct ice movement, respectively. Ice booms (Figure 2-9) and man-made islands can be used to hold ice in place and yet allow vessel passage.



Figure 2-9. Ore carrier downstream of ice boom on St. Marys River at outlet of Sault Ste. Marie Harbor. An ice boom is located about one ship length astern

## CHAPTER 3

## ENVIRONMENTAL CONSIDERATIONS IN DESIGN

3-1. Circulation and Water Quality.

a. Estuary Hydrodynamics. Many deep-draft navigation channels are located in estuaries. Estuaries are transition areas between the ocean and the freshwater inflow from rivers. Mobile Bay, shown in Figure 3-1, and Chesapeake Bay are examples of estuaries. Circulation in these areas is complex and is mainly dependent on the relative magnitudes of tidal variations in water levels and currents, freshwater inflow, density currents caused by density differences between the ocean and fresh water, and, to a lesser extent, the Coriolis acceleration. Wind and waves also become important for short durations. The mixing regime and resultant salinity distribution depend on the relative magnitudes of these forces.

(1) Mixing regimes. Three types of salinity distributions are possible: highly stratified, partially stratified, and well mixed. Figures 3-2 and 3-3 show conditions typical of stratified and partially mixed estuaries. In a highly stratified estuary, the interface between saltwater and fresh water is reasonably well defined (Figure 3-2), but in a well-mixed estuary there is a gradual transition from saltwater to fresh water and salinity differences from surface to bottom are slight.

(2) Effect of tidal variability. The tide imposes a cyclic upstream and downstream movement of salinity. In some estuaries, a strong correlation between salinity stratification and the neap-spring tide cycle exists. During spring tides, more energy is available for vertical mixing. This phenomenon has been observed in Chesapeake Bay.

(3) Effects of freshwater discharge. Another measure used to classify the degree of stratification is the ratio of the volume of fresh water discharged into an estuary over a tidal cycle to the tidal prism volume. If this ratio is greater than one, the estuary is likely to be highly stratified. As this ratio decreases, the stratification also decreases. Therefore, for a given set of tidal conditions, increasing tributary freshwater input tends to stratify the estuary, while decreasing inflows allow greater mixing.

(4) Residual circulation. Circulation in estuaries can be described as the superimposition of the back-and-forth tidal flow on a net, steady circulation. This net, steady circulation is often referred to as the "residual circulation." The residual circulation can be obtained at any point in the estuary by integrating the observed velocity at that point over the tidal cycle. Residual circulation is always present in an estuary to some degree.

(a) Tidal pumping. Tidal pumping is a term that refers to a tidal body of water in which the ebb flow path differs from the flood flow path in a consistent manner, causing a net steady circulation or "pumping" effect. One form of this circulation often occurs just inside many inlets, where the flood flow enters as a confined jet, while the ebb flow comes from all around the mouth in a much different flow pattern from the flood jet (Figure 3-4a). Another example of tidal pumping occurs in braided channels in which the



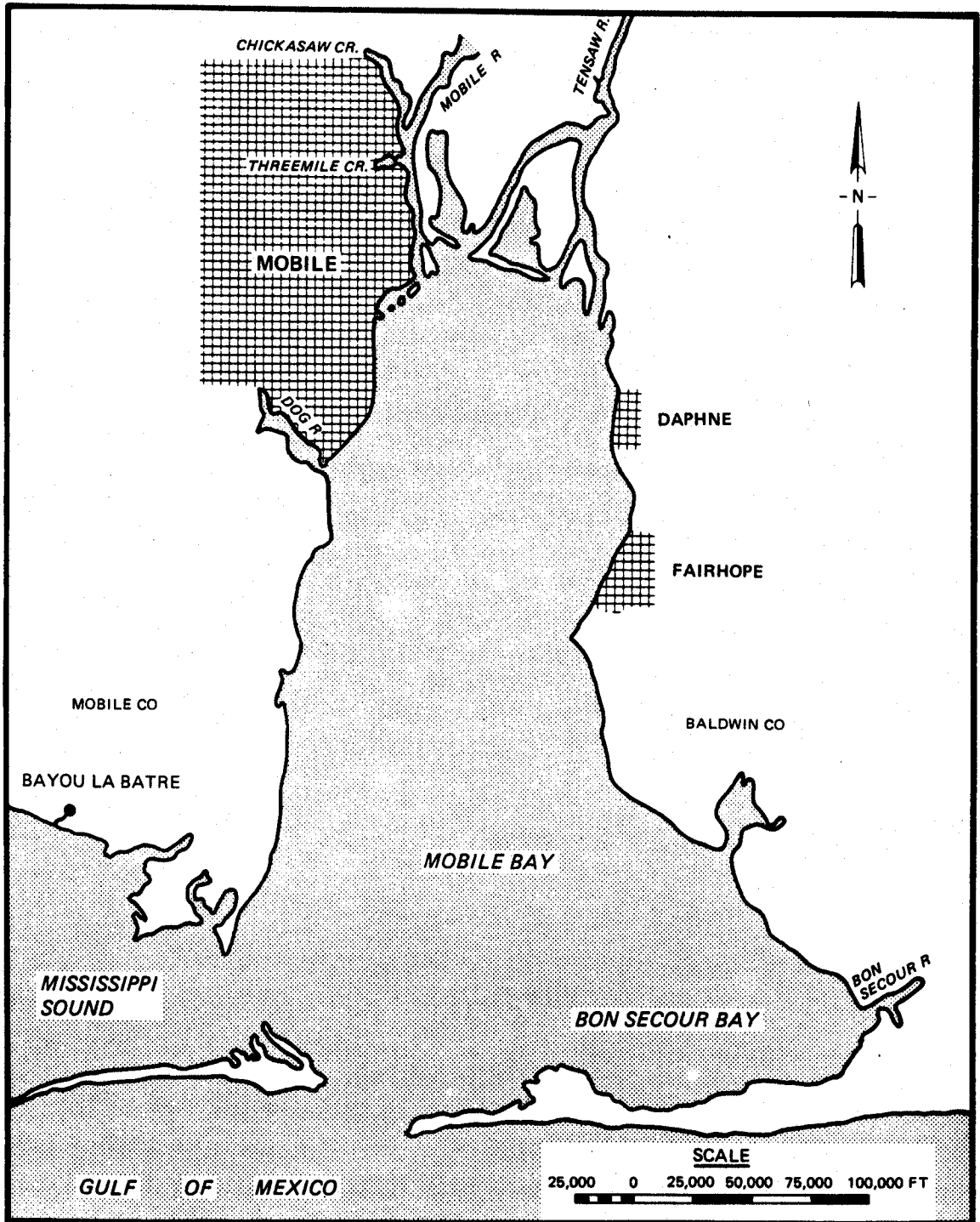

Figure 3-1. Mobile Bay estuary

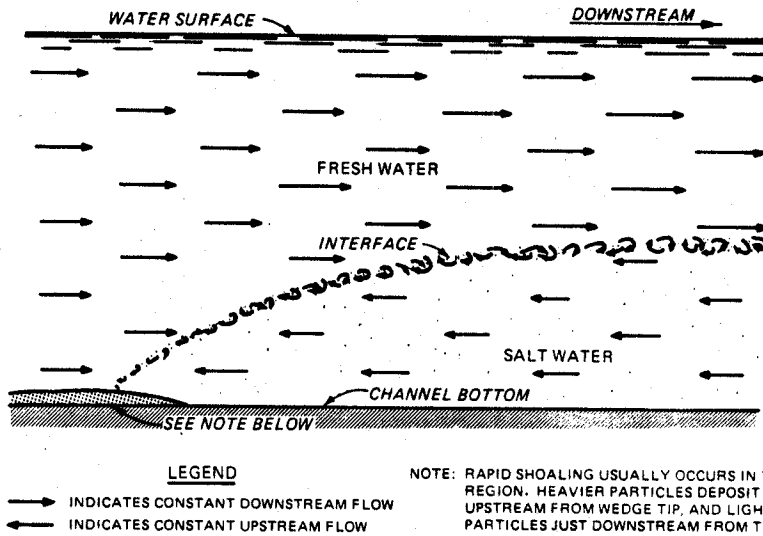

Figure 3-2. Conditions typical of highly stratified estuary

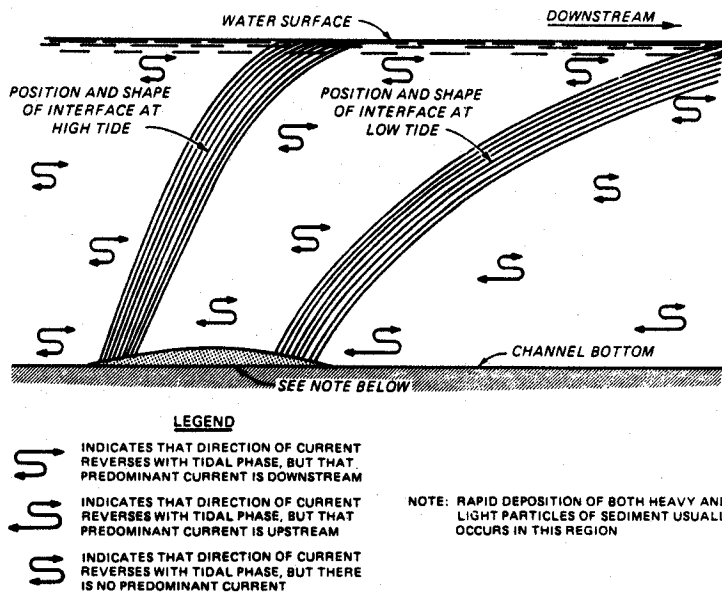
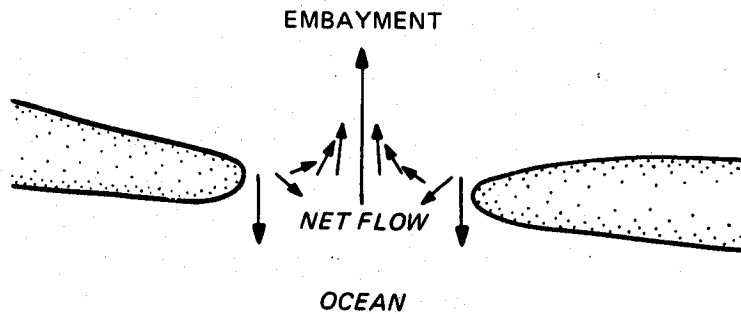
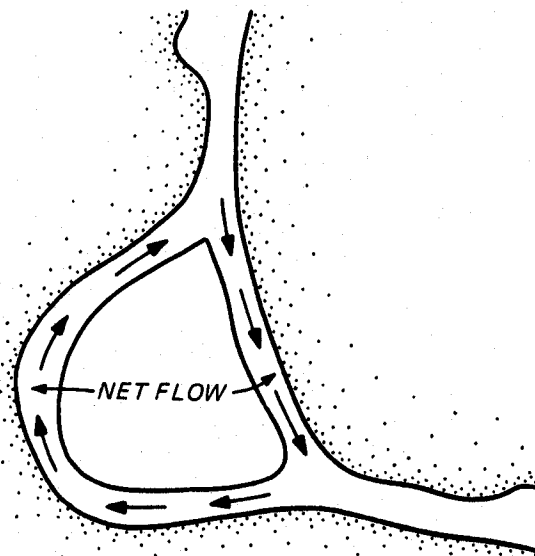

Figure 3-3. Conditions typical of partially mixed estuary



a. Residual flow pattern at an inlet



b. Residual flow pattern at River Cutoff

Figure 3-4. Examples of residual circulation caused by tidal "pumping"

distribution of flood flow is different from the distribution of ebb flow, resulting in a net, steady circulation (Figure 3-4b).

(b) Freshwater inflow. Tributary inflow causes residual circulation due to the density difference between the river and ocean water (gravitational circulation) and to the distribution of river flow within a wide estuary. Density currents are generated due to longitudinal and vertical salinity gradients. Tidal velocities greatly exceed the density currents in magnitude, but even weak currents due to salinity gradients greatly enhance the inland transport process. Whenever an estuary is highly stratified or partially mixed, density currents are generated which result in residual flow landward along the bottom and seaward along the surface in the region of the estuary below the limit of saltwater intrusion (Figure 3-5). Above the limit of saltwater intrusion, salinity gradients and resultant density currents do not exist, and the residual circulation caused by river flow is downstream both

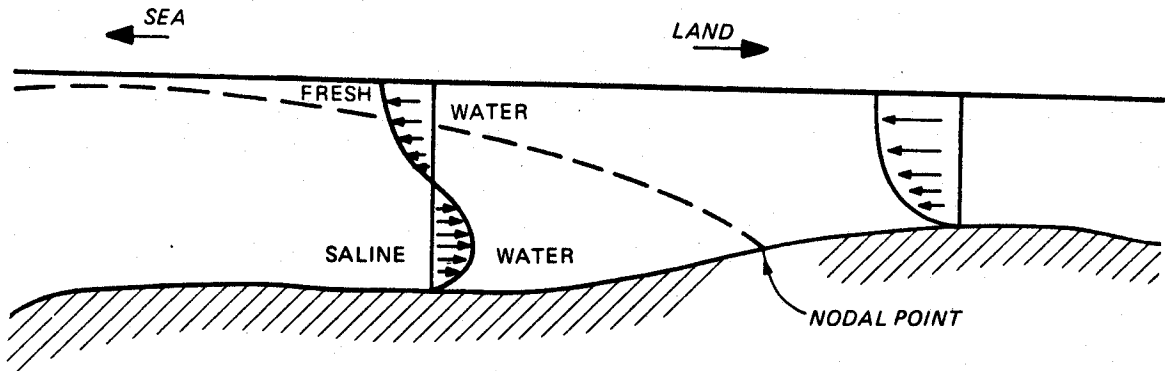

Figure 3-5. Distribution of velocity over depth in typical stratified estuary

along the surface and the bottom. Thus, a nodal point exists along the bottom at a point or points where the net transport over a tidal cycle is zero. For a highly stratified estuary, this point is near the limit of salinity intrusion; for a partially mixed estuary, it would be seaward of this limit. The nodal point represents a "trapping zone" in the lower water column which must be considered when water quality is studied.

(c) Coriolis acceleration. In large estuaries, one cause of residual circulation is the earth's rotation, which deflects currents to the right in the Northern Hemisphere and to the left in the Southern Hemisphere. To an observer facing seaward in the Northern Hemisphere, flood tide currents are deflected toward the left shoreline and ebb tide currents to the right shoreline, resulting in a net counterclockwise circulation. This inertial-induced residual circulation is also referred to as Coriolis circulation and explains why in Chesapeake Bay the salinity is, on the average, higher on the eastern shore (on the left looking seaward) than on the western shore.

(d) Wind stresses. Another type of residual current is that generated by wind stresses on the water surface. If the estuary is of sufficient size, wind stresses can generate residual circulation of considerable magnitude.

b. Changes in Hydrodynamics Due to Deep-Draft Projects. Deepening or realignment of navigation channels alters the volume of an estuary. The changes in volume are usually very small compared with total estuarine volume. Small changes in volume result in insignificant changes in tidal flow. However, channel deepening or realignment can have a major impact on residual circulation. Altered circulation can affect water quality not only along the channel but in areas of the estuary far removed from the dredged channel. In general, the effect of deepening is to increase the landward extent of salinity intrusion, and vertical salinity stratification becomes more pronounced. There is also likely to be a net increase in the vertically averaged salinity as well. Refer to Appendixes B and C for more information on the use of mathematical and physical models in deep-draft environmental studies.

(1) Deep-draft project construction usually has only indirect effects on tidal pumping and insignificant impact on Coriolis- and wind-induced

29 May 87

circulation. However, channel deepening directly impacts the gravitational circulation in that the nodal point and the resulting trapping zone are allowed to intrude further up the estuary. In addition, channel deepening tends to enhance or strengthen the gravitational circulation and intensify stratification. These changes can in turn produce changes in water quality parameters other than salinity.

(2) Excavation of a deep-draft channel in a wide or braided estuary can cause significant redistribution of freshwater inflow, producing unexpected results. In wide estuaries, channel deepening can result in portions of the estuary becoming fresher, even though the overall salt content of the estuary is increased. This phenomenon has been observed in physical model investigations of channel deepening in Mobile Bay, Alabama, and is discussed in WES TR H-75-13. A similar phenomenon, unexpected freshening of a portion of the estuary, was also noted in physical model investigations of channel deepening for Grays Harbor, Washington, which is described in WES TR H-72-2. Grays Harbor is not a wide estuary but does have multiple channels, thus allowing for the redistribution of freshwater flow as one channel is deepened.

(3) Since the salinity regime will be affected by a deep-draft channel, it is important to consider the effect it could have on water-supply intakes. During low freshwater discharge, the potential for the intake of saltwater increases. Channel deepening and resultant saltwater intrusion could result in saltwater encroachment into aquifers as well as in effluents from point discharges being carried upstream.

c. Prediction of Circulation and Water Quality Changes. A project-specific study of the impact of a deep-draft navigation channel on circulation is required to establish the exact nature of changes in water quality that would be associated with channel construction. The results of such a study can sometimes be used in evaluation of the project's beneficial or adverse effects on ecological resources.

(1) Systematic procedure. Characterization and prediction of the deviation of all water quality parameters from baseline conditions due to project construction would require excessive time and money. Therefore, the following systematic procedure should be used:

(a) Hydrodynamic modeling techniques can be used to simulate the velocity under baseline conditions and following proposed modifications. Mathematical hydrodynamic modeling and physical modeling are discussed in Appendixes C and D, respectively.

(b) Dye tracers, salinity, or DO can be used to estimate changes in dilution, detention times, and stratification.

(c) Minor changes in the velocity field can be used to postulate minor water quality impacts. This postulate may be invalid if a preliminary water quality reconnaissance indicates potential toxicant effects on biotic populations.

(d) Significant changes in dilution, detention times, or stratification indicate a need for more detailed water quality analysis.

29 May 87

(2) Detailed analysis. Detailed analysis should be limited to selected water quality constituents and should be based on a knowledge of the system hydrodynamics. Detailed evaluation should be conducted for those constituents that:

(a) Exist in concentrations approaching or exceeding numerical standards or criteria.

(b) Can be used to define habitat suitability for selected biological populations.

(c) Are of sociopolitical concern.

(d) Must be included because they interact with constituents of concern.

(3) Overall water quality analysis. Evaluation of potential water quality changes due to altered circulation should provide input to an overall evaluation of project effects on water quality. As discussed in paragraph 2-3, water quality impacts of deep-draft projects can be addressed in three categories: (a) dredging and disposal during construction and maintenance; (b) increased pollutant loadings due to facility construction, vessel discharges, and accidental spills; and (c) altered circulation due to changes in geometry. Categories (a) and (b) primarily describe the introduction and mobilization of water quality constituents and can be mathematically modeled through source and sink terms.

### 3-2. Prevention and Control of Salinity Intrusion.

a. Approach. In order to reduce salinity intrusion, several approaches can be considered:

(1) Blockage of the saltwater path.

(2) Increased mixing.

(3) Constriction of the estuary cross section.

(4) River flow regulation.

b. Blockage of Saltwater Path. Complete blockage of the saltwater path can be accomplished by placement of a barrier extending from the channel bottom up through the saline layer, which for a highly stratified estuary might be just a portion of the channel depth, but for a well-mixed estuary might extend through the entire water column (Figure 3-6). This type of barrier might be a curtain or inflatable barrier that could be opened to allow navigational traffic or a dam-type barrier accompanied with a lock structure if navigation is desired past the barrier. The Calcasieu River saltwater barrier, Louisiana, is an example of this method of salinity control (US Army Corps of Engineers 1971). Some additional methods might be needed to block saltwater that intrudes through the lock or past the mobile barriers. Methods that have been used for salinity control include: complete exchange of salt/freshwater while lock gates were closed, air screens, water screens, locking by pumping instead

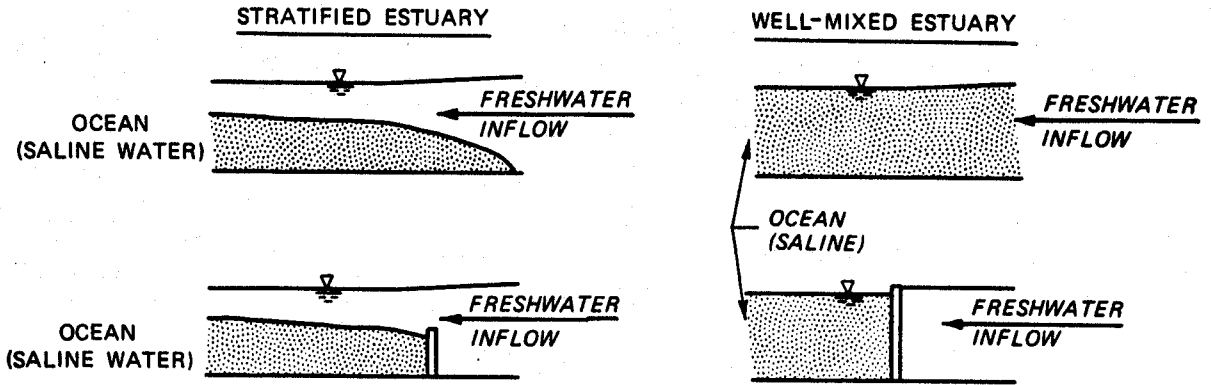

Figure 3-6. Schematic of blockage of saltwater path

of gravity, selective withdrawal during intrusion, and selective withdrawal after intrusion has taken place.

c. Increased Mixing. If a region of the estuary is stratified, the length of salinity intrusion can be reduced by creating greater mixing of the fresh and saline waters (Figure 3-7). In effect, this is making greater use of the river flow. Pneumatic barriers (air screens) or hydraulic barriers (water screens) could theoretically be used to increase mixing; however, these methods have not been attempted in a prototype application. Barriers that constrict flow also induce mixing. However, this method has rarely been used for general estuarine salinity intrusion, and the use of pneumatic barriers has been confined to intrusion through navigation locks.

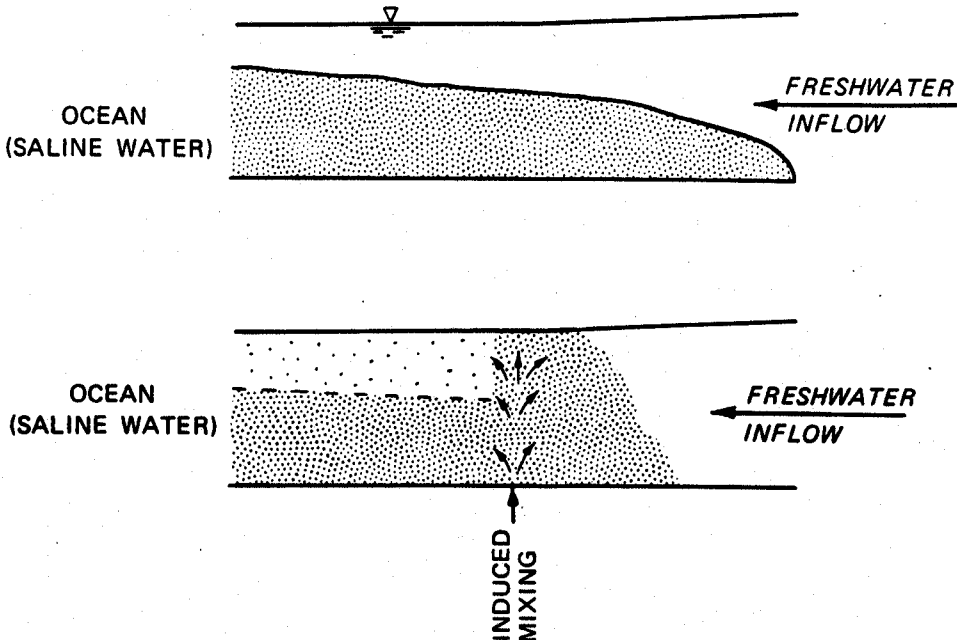

Figure 3-7. Schematic of mixing using pneumatic barrier

29 May 87

d. Constriction of Estuary Cross Section. Constriction of the estuary cross section could reduce tidal fluctuations above the constriction and would not reduce the freshwater flow through the estuary. This method would be of benefit primarily if intrusion were a problem only during a portion of tidal cycle (Figure 3-8). It would be of less value in an estuary with a very low

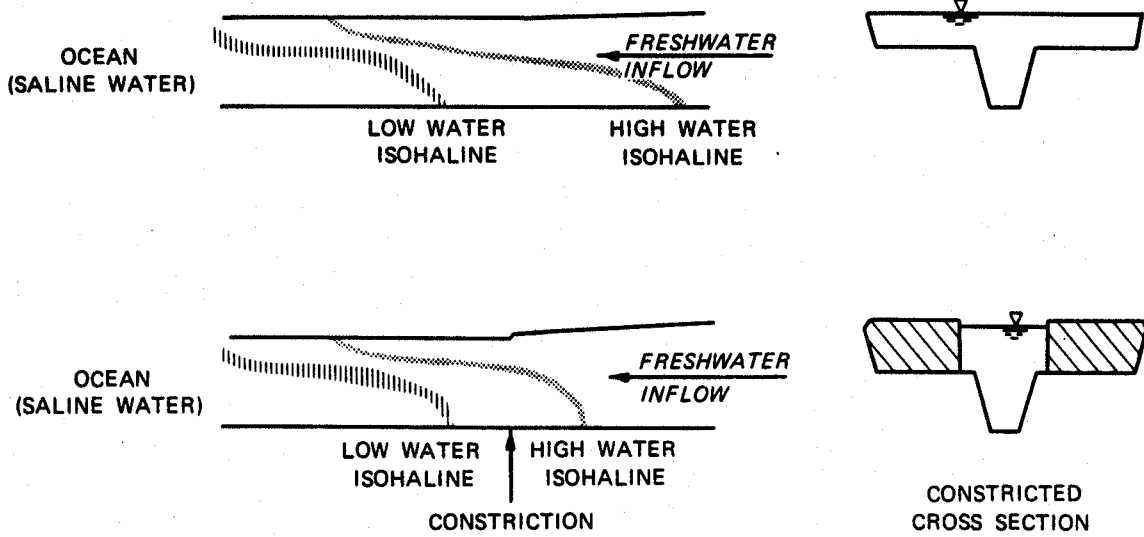

Figure 3-8. Schematic of estuary constriction

tidal range, where the length of salinity intrusion might not vary greatly during the tidal cycle. If, for instance, the length of salinity intrusion increased considerably from low water to high water slacks due to a large tidal range, constriction could be an effective measure. The constriction might consist of dikes across the shallow to reduce the cross section and force freshwater flow to the channel. Barriers in the navigation channel would again have to be mobile or deep enough not to interfere with navigation.

e. River Flow Regulation. If salinity intrusion were only a seasonal problem occurring during drought periods, regulation of freshwater inflow with reservoirs might be sufficient to keep the saline water seaward by moderating seasonal flow variation. Provision of storage for this purpose must usually be done in the planning stage to avoid conflicts among competing water uses. Low-flow augmentation might also significantly alter mixing (and thus circulation) characteristics during the low-flow periods. Careful monitoring and complex riverflow regulation have been used in the San Francisco Bay and Delta system to moderate salinity intrusion.

f. Investigation. The process of salinity intrusion is quite complex as a result of several interrelated phenomena. This has made the design of salinity intrusion mitigation measures correspondingly complex. Therefore, a study of salinity intrusion mitigation measures generally requires an extensive project-specific investigation of siting, operation, and usefulness of control measures. This could involve a numerical or physical model, laboratory testing, field data efforts, or some combination of these techniques.



### 3-3. Sedimentation Effects.

a. Sedimentation Processes. Sedimentation processes in inland or coastal deep-draft navigation projects may be classified according to the physical characteristics of the sediment as either cohesive or noncohesive. Inland riverine sedimentation is composed primarily of noncohesive sands and silts, whereas coastal shoaling usually covers a wide range of sediment sizes, from coarse sand and shell fragments to cohesive clay particles. A good review of estuarine sedimentation processes may be found in Ariathurai (1982). Dyer (1979) provides much of the information necessary for data collection and estimation of parameters.

(1) Noncohesive sedimentation. Noncohesive sediment particles are transported as individuals. A grain on the bed begins to move when the lift and drag exerted on it by the flow overcome the restraining forces of grain weight and friction. The particles may roll or be entrained in the flow for a period. There is a continuous interchange of grains between the bed and the sediment in transport. When the capacity of the flow to transport sediment is equal to the sediment supplied, the deposition and erosion are in balance and a stable bed results. If the supply and the flow capacity to transport are not equal, the bed will either aggrade or degrade. Many formulas to estimate the discharge of bed sediment under conditions of uniform steady flow have been developed. These transport functions are primarily dependent on the grain-size distribution and flow conditions. Measurement of these parameters and necessary procedures and methodologies may be acquired from several publications (Thomas 1976; US Geological Survey 1972; Schmid and Schmid 1979).

(2) Cohesive sedimentation. The behavior of cohesive sediments differs from that of noncohesive sediments due to the essence of interparticle bonds. These bonds are manifested in the flocculation (sticking together) of particles to increase settling velocity, and entrainment occurs only when the interparticle bonds are broken. The erosion rate of the cohesive beds is linearly dependent on the hydraulic shear stress at the bed above some critical value. Cohesive sedimentation results when shear stress on the bed is insufficient to prevent contact of suspended particles and the bed or to resuspend particles that reach the bed. The rate of deposition also varies linearly with bed shear stress.

b. Project Effects on Shoaling Rates. The construction of deep-draft navigation channels often leads to increased shoaling rates, and rates are usually directly related to project dimensions. Shoaling in a riverine environment is usually dominated by the peak flow periods when the sediment supply is very large. Increased channel dimensions result in lower transport capacity, and when the sediment supply is large, the increase in shoaling can be substantial.

(1) Shift of nodal point. Estuarine shoaling is complex, with the driving mechanisms originating from the tide, wind-generated waves, freshwater inflow, density gradients, and interaction of shallow and deep regions. As described in paragraph 3-1 above, the density difference between fresh water and saltwater produces density currents that create a trap near the nodal point or points along the channel bottom where the net transport is zero over a tidal period. Residual circulation patterns also result in sluggish net flow.

Sediment is transported to these trapping, or null, zones both from the landward and seaward directions, and these zones usually experience high suspended sediment concentrations and high shoaling rates. An example is shown in Figure 3-9. This shows the location of the null zone for 1953-1954 shoaling in Savannah Harbor for particular channel conditions. Also shown are the shoaling conditions along the channel, with the highest shoaling occurring near the null zone. Navigation channel construction results in landward movement of the null zone, which in turn causes the high shoaling rate region to also shift upstream. Experience in changed shoaling distribution due to several factors is summarized by Simmons (1965).

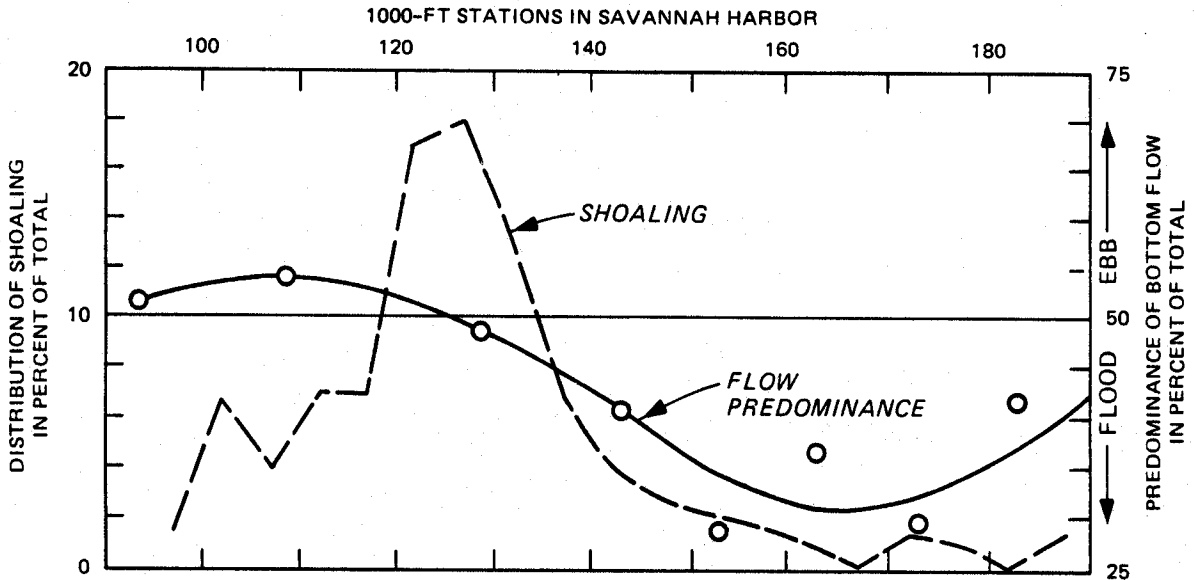

Figure 3-9. Relation of shoaling and null zone location

(2) Exceptions. While it is common for channel construction or enlargement to result in increased maintenance requirements, this is not always the case. For example, the change in shoaling rate with channel enlargement, as indicated by the amount of accumulated new work, for Galveston Channel and Houston Ship (Bay) Channel in Texas are shown in Figures 3-10 and 3-11, respectively. The amount of shoaling increased with channel enlargement early in the projects' histories, but since then the shoaling rate has shown no increase. In fact, there is a slight downward trend. Estuarine channels, unlike riverine systems, have flow rates in which the tidal portion is determined by the dimensions of the channel and estuary. So an enlarged channel will have a greater volume of cyclic flow passing along it and may not show a velocity decrease after channel enlargement.

c. Sediment Control and Management. It is difficult to reduce shoaling rates in estuarine channels since they are efficient sediment traps. Reduction of shoaling rates may be accomplished either by reduction of the sediment supply or by enhancement of the transport capacity of the channels. Generally, the reduction of sedimentation rates in estuaries has been accomplished by increasing transport capacity. Methods include training works that concentrate flow in the channel, modification of the channel geometry by smoothing expansions and contractions, and channel realignment. Sediment management includes

**EQUATION OF THE CURVE**

$Y = AX^2 + BX$

WHERE  $A = -0.00864$

$B = 0.21987$

**NOTE: CURVE IS WEIGHTED BY THE NUMBER OF SHOALING PERIODS INDICATED BY THE NUMBER WITHIN THE SYMBOL. A.M. = ADVANCE MAINTENANCE.**

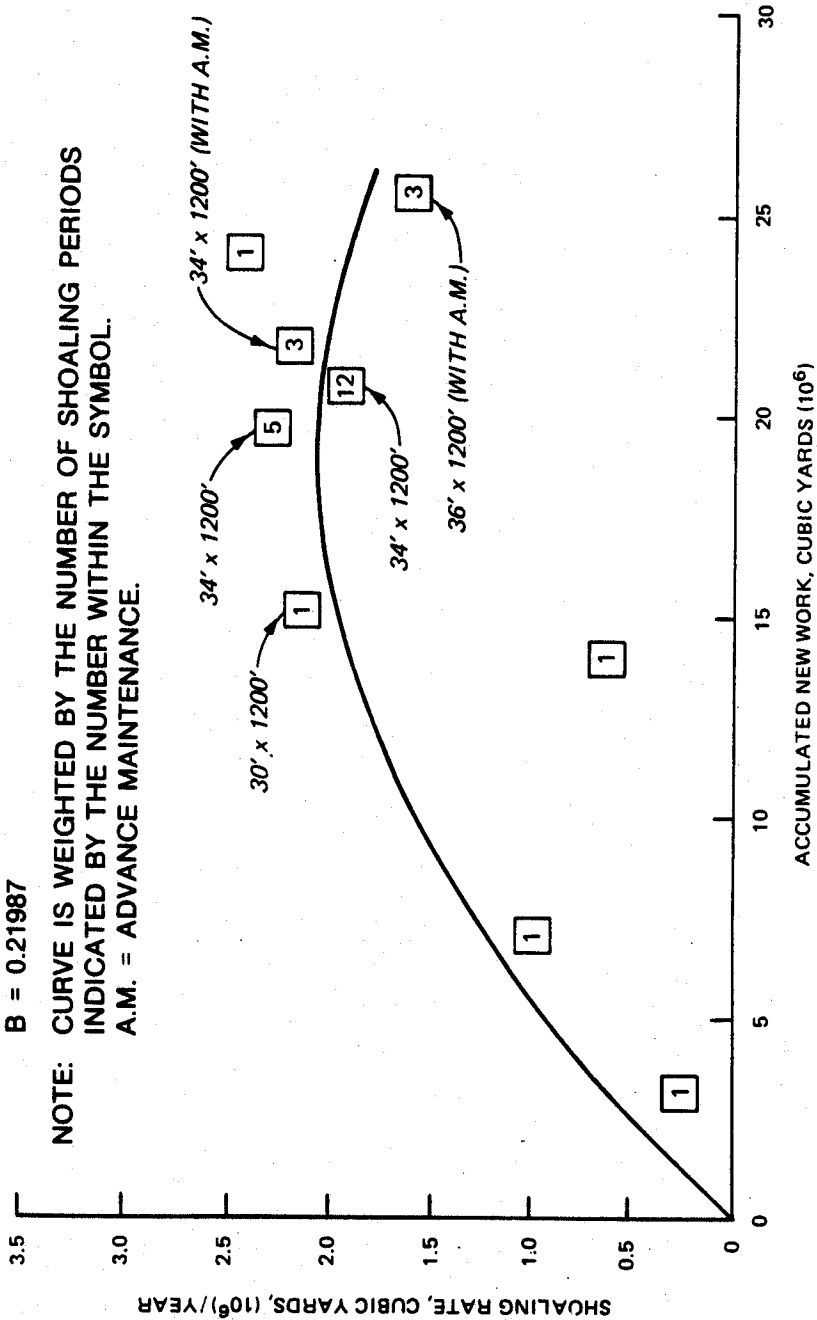

Figure 3-10. Change in shoaling rate, Galveston Channel

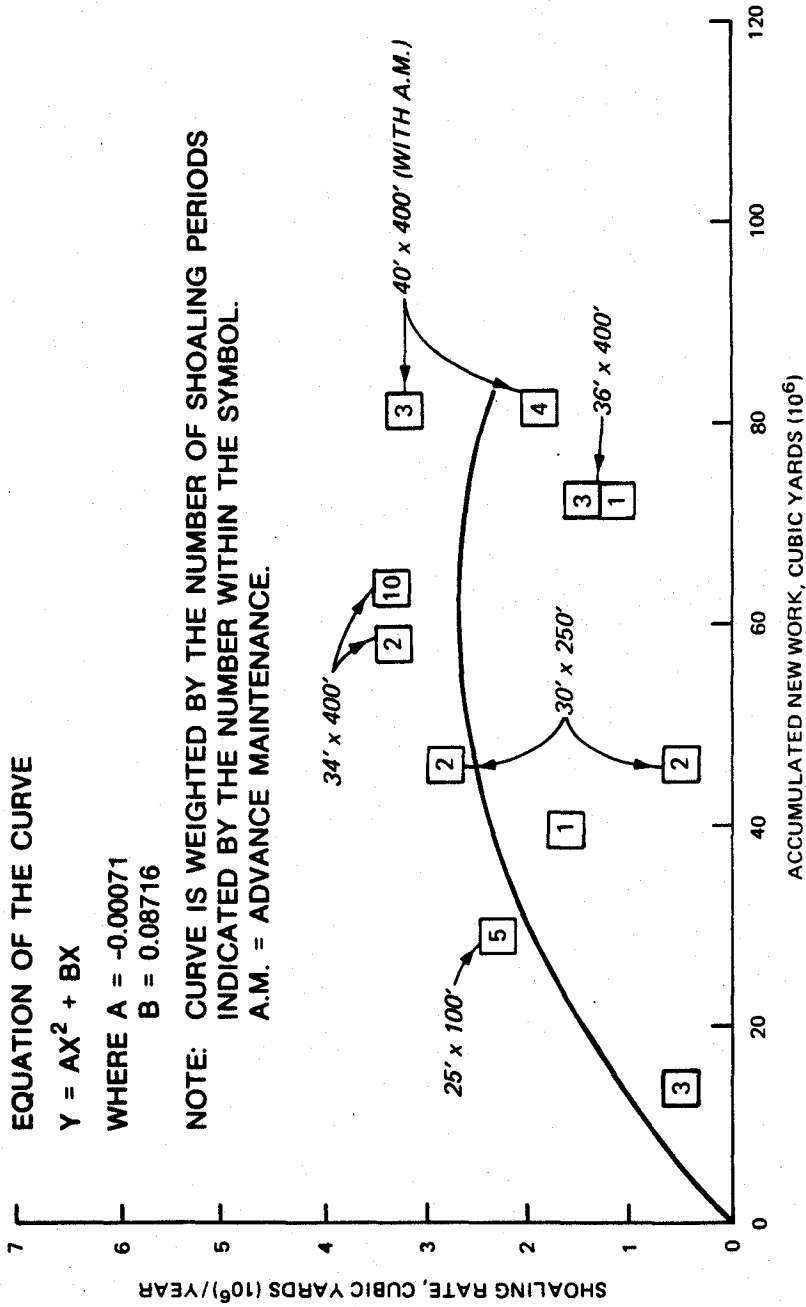

Figure 3-11. Change in shoaling rate, Houston Ship Channel

special dredging techniques such as overdepth or overwidth dredging, advance maintenance, and use of sediment traps.

(1) Training works. Training works have frequently been used to increase transport potential and to reduce shoaling. These have consisted of jetties, pile dikes, jacks, and rock-filled pile dikes. Additionally, the presence of the channel and associated navigation may necessitate bank protection. Various types of revetments, rock windrows, pervious fences, and groins, as well as training structures, are described in "Sedimentation Engineering" (Vanoni 1975). Training works (except for jetties) are much more common in shallow-draft waterways than deep-draft. A more detailed discussion of environmental considerations in the design of training work is given in US Department of the Army, Office, Chief of Engineers (1984).

(2) Dredging tolerance. Dredging tolerance is the additional depth below project depth in which the contractor is allowed to remove material for pay to ensure that minimum project dimensions are provided. This tolerance is allowed because the contractor cannot precisely control the position of the dredge suction. Minimizing dredging tolerance will in turn minimize the total volume of maintenance dredging.

(3) Advance maintenance. Advance maintenance is the technique whereby the channel is enlarged beyond project dimensions to provide additional time before the project needs redredging. Additional information on the use of advance maintenance is given in Trawle (1981).

(a) Estuarine projects that do not experience increased shoaling rates after channel deepening are good candidates for advance maintenance. Costs associated with mobilization and demobilization for dredging operations can be reduced if the additional depth provided by advance maintenance provides a reduced dredging frequency.

(b) It is doubtful that advance maintenance, generally applied, would be particularly satisfactory in riverine conditions, as the amount of maintenance dredging would increase and the dredging frequency, if determined by the peak flow event, would not be reduced. However, it may prove useful to apply in a few short reaches that experience high shoaling during nonpeak flows and have to be redredged before the bulk of the project needs redredging. These critical regions may be deepened beyond project dimensions to allow the elimination of an intermediate dredging operation.

d. Ecological Significance. Sedimentation processes are important modifiers of habitat quality; the bottom sediment (substrate) characteristics such as percent organic carbon, grain-size distribution, sediment depth, and shear strength are major factors influencing the distribution of marine benthic organisms and have also been demonstrated to be important factors for estuarine organisms. Composition and stability of both unconsolidated and consolidated sediments affect the types of benthos found on any particular bottom. Substrates are vital for attachment and as a food source for associated benthos. Sessile epifaunal benthos require consolidated, firm substrates for attachment. Burrowing, suspension-feeding, and tube-building types of benthos modify the quality and may enhance the stability of unconsolidated sediments by binding inorganic and organic particles together as fecal pellets and pseudofeces, by

the redistribution of sediments during feeding activities or tube building, and by the secretion of mucopolysaccharides. Benthic infauna may influence sediment stability and subsequent erodibility by reworking the near-surface sediment layers and increasing porosity due to subsurface burrowing activities. Kendall (1983) provides additional detail regarding the role of physical-chemical factors in structuring subtidal marine and estuarine benthos.

### 3-4. Biological Considerations.

a. Disturbance Avoidance. The primary method to alleviate adverse biological effects associated with deep-draft navigation projects is to avoid disturbing and impacting environmentally sensitive areas. Project activities should be located in the least ecologically significant area available. For example, minor adjustments in channel alignment may prevent the destruction of an oyster reef or mussel bed. Structure designs should be carefully analyzed to determine the size, placement, and composition that are the least detrimental and the most beneficial. Use of materials with wide size gradations, such as quarry run stone, for structures results in aquatic habitat diversity due to the variety of sizes and shapes of crevices. This diversity allows utilization by different sizes and types of organisms.

b. Marsh Protection. Protective structures may be built to reduce impacts to valuable aquatic and terrestrial habitats in the shore zone. Figure 3-12 depicts concepts for several types of structures that may be used to protect natural or man-made marshes.

c. Fishery Management. A variety of fishery management techniques are available and may be feasible for increasing project benefits. Schnick et al. (1982) gives detailed information on these techniques.

(1) Structural and/or mechanical devices can be used to minimize the effects of dams and locks and intakes on fish populations.

(a) Fishways (fish ladders) have been used at a number of dams and locks to allow upstream movement of fishes. Fish negotiate fishways under their own power, whereas fish elevators or lifts transport fish (mechanically) upstream over a dam. Fishes whose upstream migration has been aided by fishways or fish lifts include salmon, steelhead, American shad, river herring, and striped bass.

(b) Fish screens and barriers aid in preventing the entrainment or impingement of fishes at industrial, irrigational, hydroelectric, and municipal water intakes.

(2) Placement of fish-spawning structures and fish attractors are additional fishery management techniques that can be used in waterways (Figure 3-13). Due to the extremely powerful forces exerted during storm and flood conditions, such devices need to be constructed of very dense materials (e.g., concrete blocks or vitrified clay pipe bundles) and placed in areas where less powerful current velocities occur.

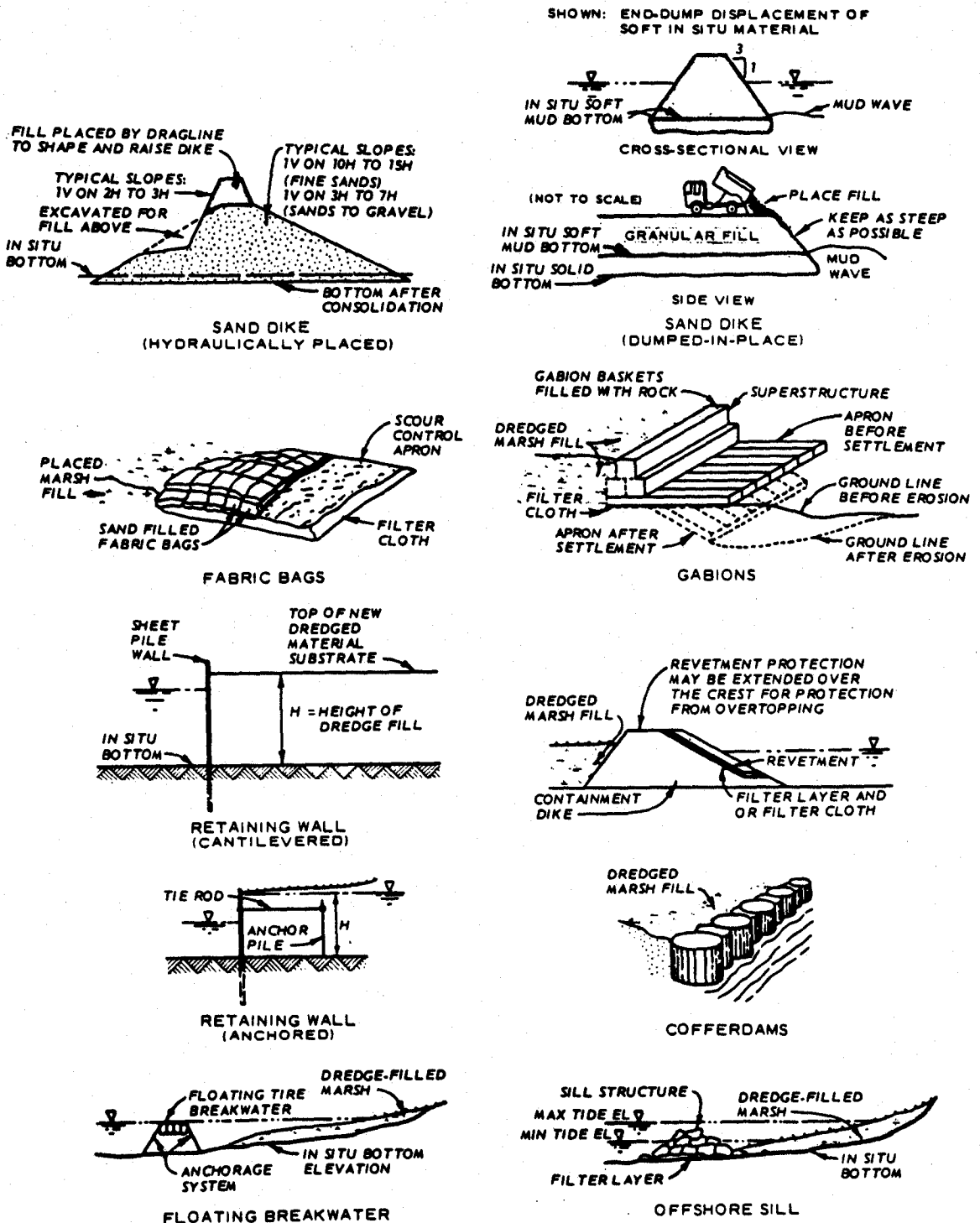

Figure 3-12. Marsh retention and protection structures

29 May 87

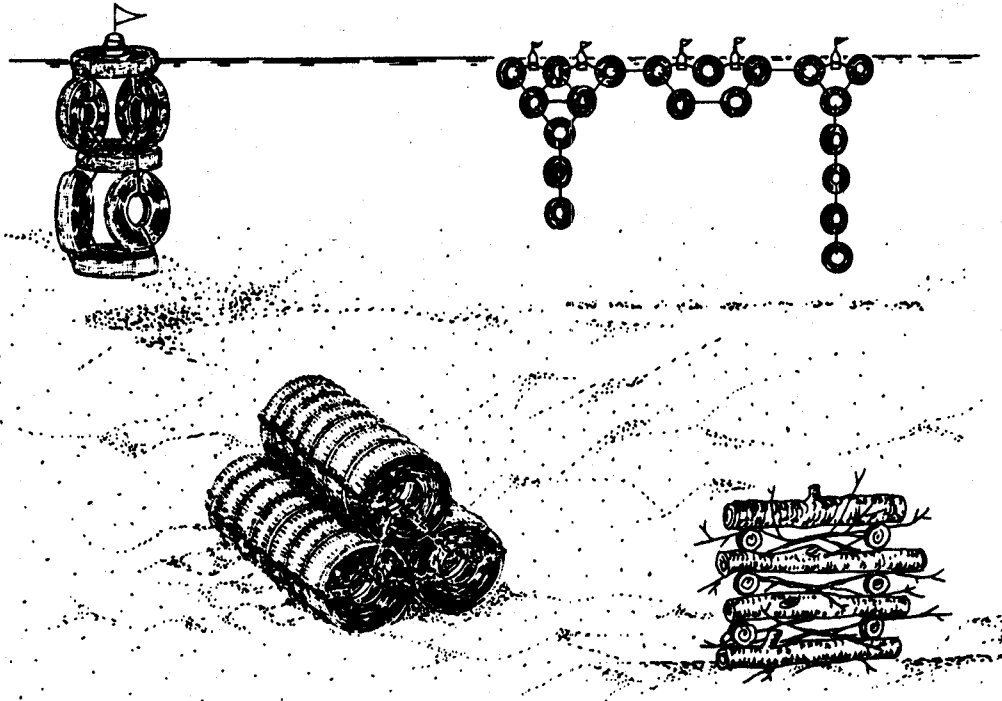

Figure 3-13. Fisheries habitat enhancement structures located adjacent to navigation channel

(3) The development of nursery ponds or coves is another technique for use along waterways. In these areas young fish of a single species are reared in a productive nursery area where they are isolated and are secure from predation. When fish reach a certain size and age, they are released into the aquatic system.

(4) The best overall fisheries management strategy is to manage the aquatic system so that a diversity of habitats is present, and spawning and nursery areas are available and preserved.

### 3-5. Dredging Effects Considerations.

a. General. Dredging is a major activity in developing deep-draft navigation projects. During the design phase of such projects, the environmental effects associated with dredging and dredged material disposal must be considered. Dredging for navigation projects requires consideration of both short- and long-term management objectives. The primary short-term objective of a deep-draft project is to construct a channel for navigation to authorized project dimensions. This should be accomplished using the most technically satisfactory, environmentally compatible, and economically feasible dredging and dredged material disposal procedures. Long-term dredging objectives concern the efficient management and operation of dredging and disposal activities required to continue operation and maintenance of the navigation project. The environmental considerations required to support the design of new-work dredging for deep-draft navigation projects are discussed below.



b. Basic Considerations. In order to consider the environmental aspects of dredging and dredged material disposal in the design phase of a project, the following activities are required:

<u>Step</u>	<u>Information Source</u>
(1) Analyze dredging location and quantities to be dredged	Hydrographic surveys, project maps
(2) Determine the physical and chemical characteristics of the sediments	WES TR DS-78-10 (Section 5-2)
(3) Determine whether or not there will be dredging of contaminated sediments	WES TR DS-78-6
(4) Evaluate disposal alternatives	EM 1110-2-5025
(5) Select the proper dredge plant for a given project	EM 1110-2-5025
(6) Determine the levels of suspended solids from dredging and disposal operations	WES TR DS-78-13
(7) Control the dredging operation to ensure environmental protection	WES TR DS-78-13
(8) Identify pertinent social, environmental, and institutional factors	Para 2-1
(9) Evaluate dredging and disposal impacts	WES TR DS-78-1 WES TR DS-78-5

Although dredging and related matters have traditionally been considered an operations and maintenance function, a well-coordinated approach in the planning and design stages can minimize problems in the operation and maintenance of the project. This is especially true regarding long-range planning for disposal of both new-work and maintenance dredged material.

c. Equipment Selection.

(1) Most Corps dredging is performed by private industry under contract, and the specifications should not be written such that competitive bidding is restricted. However, in certain situations, limitations may be placed on the equipment to be used to minimize the environmental impact of the dredging and disposal operation. For example, where the available upland containment areas are small, the size of the dredge should be restricted to minimize stress on the containment area dikes, to provide adequate retention time for

sedimentation, and to minimize excessive suspended solids in the weir effluent. Environmental protection is adequate justification for carefully controlling the selection and use of dredging equipment. Deep-draft navigation channels normally are constructed by either hydraulic pipeline cutterhead dredges (Figure 3-14) or mechanical bucket dredges (Figure 3-15) because they are ideal for the removal of the hard and compact materials often found in new-work dredging projects. Hopper dredges are also used for new-work as well as maintenance dredging where the materials to be removed are reasonably soft.

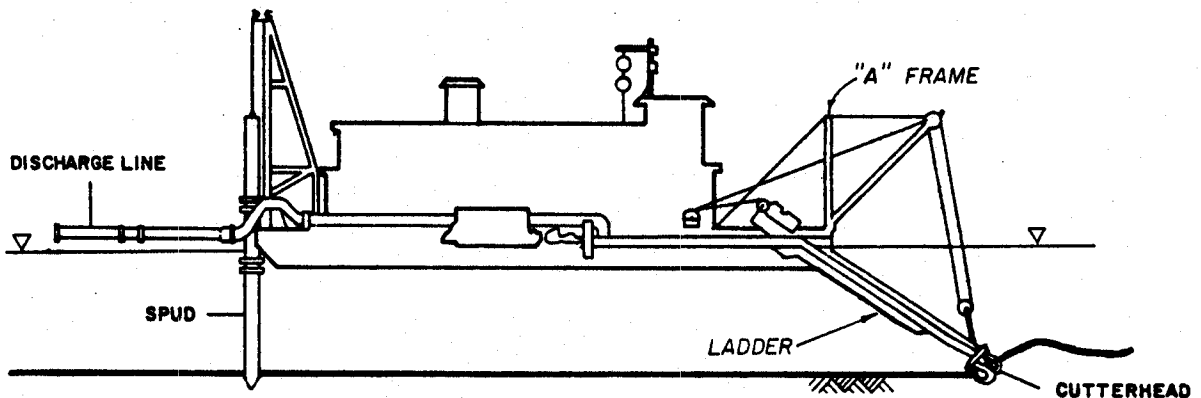

Figure 3-14. Hydraulic pipeline cutterhead dredge

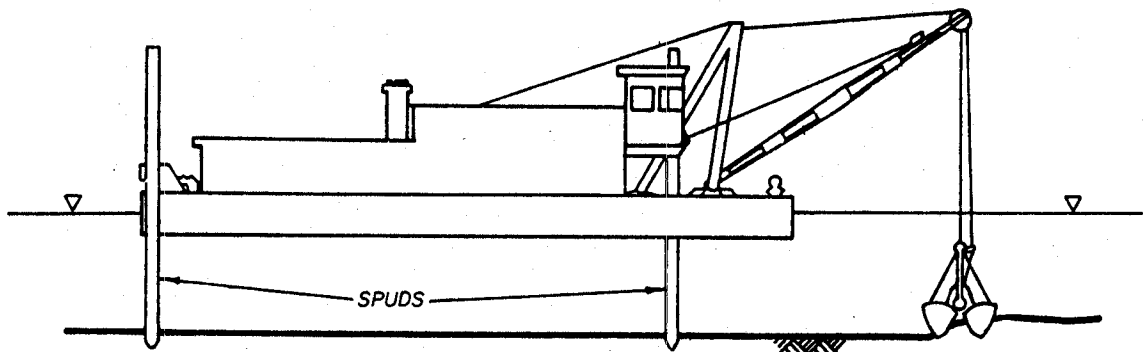

Figure 3-15. Mechanical bucket dredge

(2) The environmental effects commonly associated with dredging operations are increases in turbidity, resuspension of contaminated sediments, and decreases in DO levels. However, research results indicate that the traditional fears of water quality degradation resulting from the resuspension of dredged material during dredging and disposal operations are for the most part unfounded. More detailed information on the impacts of turbidity and the possible impact of depressed DO levels is given in paragraph 2-4 of this manual and EM 1110-2-5025.

(3) In some cases, the environmental impact associated with the dredging of uncontaminated sediment may be insignificant. However, the impact of fluid mud dispersal at open-water pipeline disposal operations appears to be significant, at least for short time periods (i.e. months). Regardless of the

29 May 87

type of dredging or disposal operations, there are certain environments (e.g., spawning grounds, breeding areas, oyster and clam reefs, areas with poor circulation) and organisms (e.g., coral, sea grasses, benthos) that may be extremely sensitive to high levels of turbidity and/or burial by dredged material. It is therefore necessary to evaluate the potential impact of each proposed operation on a site-specific basis, taking into consideration the character of the dredged material, the type and size of dredge and its mode of operation, the mode of dredged material disposal, and the nature of the dredging and disposal environment. The seasonal cycles of biological activity and the degree and extent of the potential short- and long-term impacts relative to background conditions in the areas to be dredged must also be evaluated. Although some of the impacts associated with existing dredging and disposal procedures are proving not to be as severe as previously alleged, techniques to minimize environmental impacts must be employed. These include implementing the guidelines given in this manual for evaluating the existing and resultant conditions, selecting dredges, improving operational techniques, properly using silt curtains, and selecting appropriate pipeline discharge configurations. Sources of guidance on dredging activities are listed below.

<u>Activity</u>	<u>Information Source</u>
Selecting dredge	EM 1110-2-5025
Improving operational techniques	EM 1110-2-5025 WES TR DS-78-13
Properly using silt curtains	WES TR DS-78-13
Selecting appropriate pipeline discharge configurations	WES TR DS-78-13

#### d. Disposal Alternatives.

(1) While selection of proper dredging equipment and techniques is essential for efficient dredging, the selection of a disposal alternative is of equal or greater importance in determining viability of the project, especially from the environmental standpoint. Three major disposal alternatives are available: open-water disposal, confined disposal, and habitat development.

(2) Each of the major disposal alternatives involves its own set of unique considerations, and selection of a disposal alternative should be made based on both economic and environmental considerations. A brief description of environmental considerations relating to each of the disposal alternatives is given in the following paragraphs. More detailed guidance is given in Section 4-1 and EM 1110-2-5025.

#### e. Beneficial Uses.

(1) General. The acquisition of suitable disposal acreage is probably the most common problem among Corps Districts related to deep-draft dredging. The problem exists because of the general perception of dredged material as a waste product and because of competition between dredged material disposal area development and other land uses. Often the materials dredged during

29 May 87

construction of deep-draft projects are ideal for beneficial uses such as marsh nourishment, upland habitat development, and as construction materials. Figure 3-16 shows a marsh and upland habitat developed using sand from a dredging project.



Figure 3-16. Bolivar Peninsula marsh and upland habitat development site, Galveston Bay, Texas

(2) Source documents. The following documents provide more detailed information on beneficial uses of dredged material.

<u>Use</u>	<u>Information Source</u>
Marsh nourishment	WES TR DS-78-16
Upland habitat development	WES TR DS-78-17
Land improvement using dredged material	WES TR DS-78-12 WES TR DS-78-21

(3) Example. Figure 3-17 illustrates potential marsh nourishment alternatives for bay and river sites using dredged material from an adjacent deep-draft navigation channel. This is an example of the beneficial use of dredged material in areas where the existing marsh is being destroyed by natural erosion and land subsidence.

f. Long-Range Planning. Dredging and disposal activities cannot be planned independently for each of several projects in a given area. While each project may require different specific solutions, the interrelationships among them must be determined. Thought must also be given to changing particular dredging techniques and disposal alternatives as conditions change. Long-range

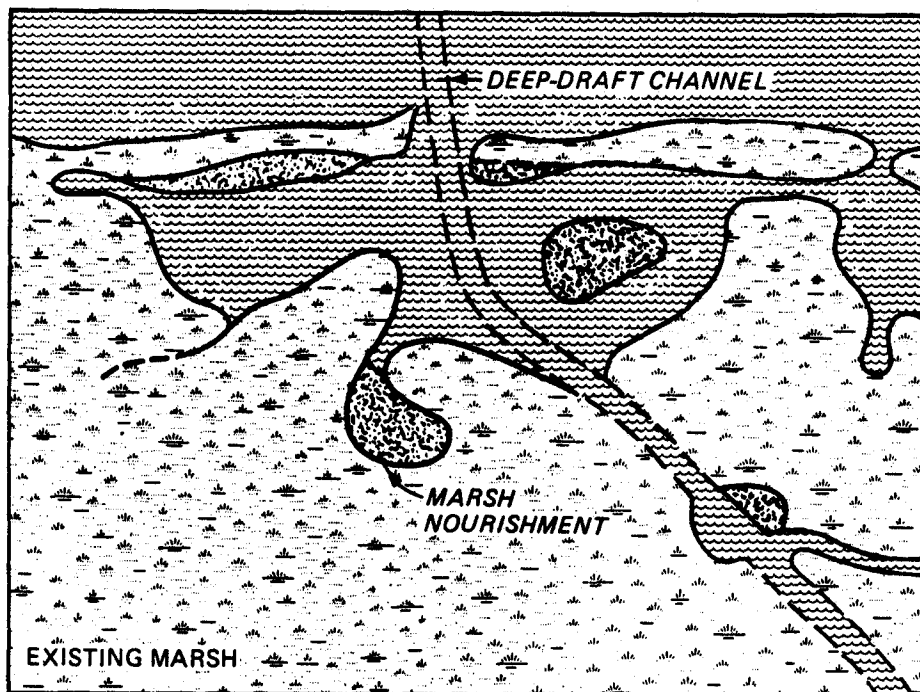

Figure 3-17. Marsh nourishment potential of dredged material at bay and river sites

regional dredging and disposal management plans not only offer greater opportunities for environmental protection and effective use of dredging equipment at reduced project cost, but they also meet with greater public acceptance once they are agreed upon. Long-range plans must reflect sound engineering design, consider and minimize any adverse environmental impacts, and be operationally implementable.

### 3-6. Associated Activities.

a. The enlargement and/or deepening of existing Federal channels or construction of new Federal channels will normally be associated with concurrent enlargement and development of non-Federal connecting channels and anchorages. Such non-Federal development should be considered in the overall evaluation of environmental effects resulting from changes in circulation patterns, velocities, salinities, etc., and from navigation traffic and spills.

b. Non-Federal channel enlargements will also result in additional volumes of new-work dredged material and perhaps increases in recurring maintenance volumes. Disposal areas used for Federal dredging activities are often used for non-Federal disposals as well. Therefore, requirements for disposal from associated activities should be considered in the selection of dredged material disposal alternatives and in the development of long-range disposal plans. Timing of non-Federal dredged material disposal activities should also be considered in long-range plan development. Since it is advantageous in many cases to dewater upland sites for long periods to promote drying and consolidation, ponding these sites for non-Federal as well as Federal work should be planned and scheduled.

29 May 87

c. Other associated activities may be intensified as a result of Federal and non-Federal channel development. Such activities include wharf and pier construction, fill construction, and associated industrial development (Figure 3-18). These activities may occur in stages and may be closely integrated with the major channel development. Opportunities for development of recreational facilities and fish and wildlife habitat (especially if staged construction is planned) should be considered in the planning and design stages.

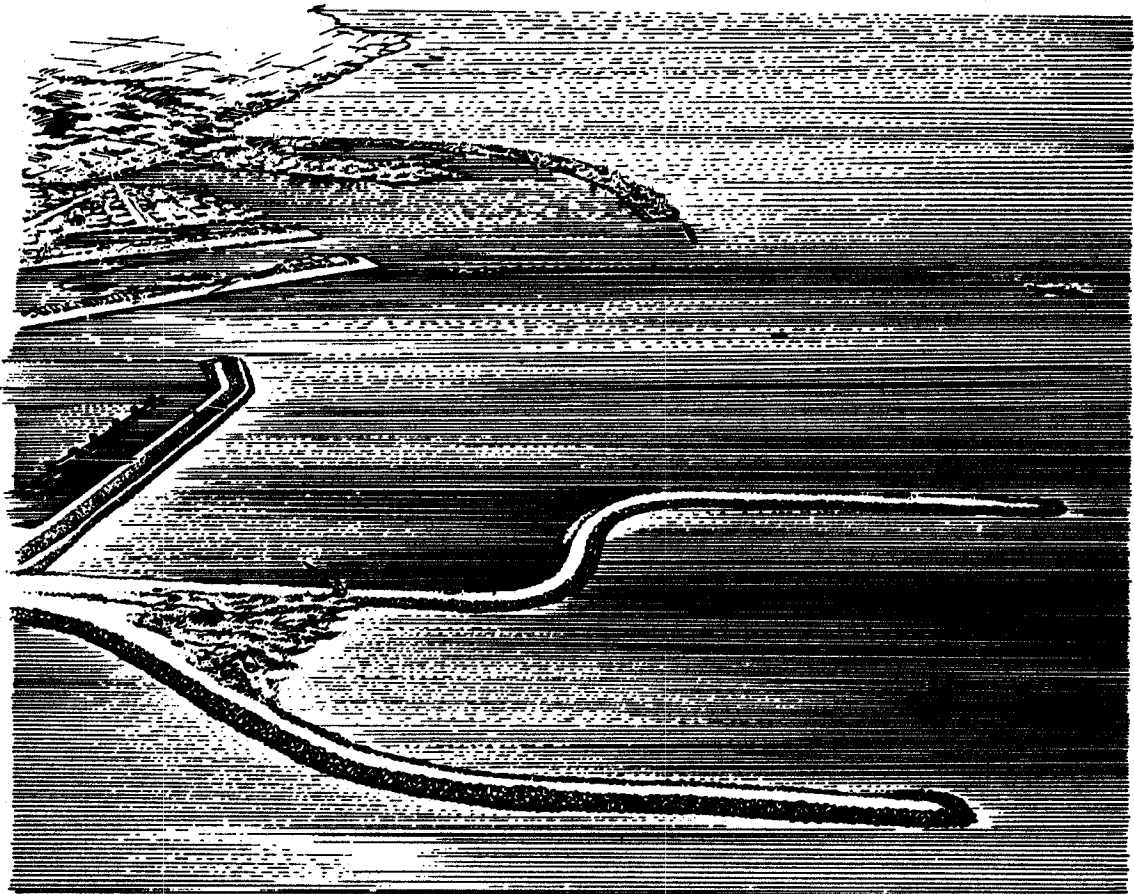

Figure 3-18. Expansion of harbor facilities as a result of deep-draft navigation channel

d. Figure 3-18 illustrates a potential non-Federal channel development activity associated with deep-draft navigation projects. This harbor was developed as close as possible to deep water for reception of larger container vessels. A number of impacts must be considered as a result of such development:

EM 1110-2-1202  
29 May 87

Impact

The extension of harbor facilities into the ocean would have an impact on hydraulics. Current velocities would increase if the facilities constricted flow.

Some morphological changes may occur if unstable channel banks and shoreline exist in the area.

Increased currents would likely cause impacts on navigation.

Information Source

ER 1110-2-1404  
EM 1110-2-1613

EM 1110-2-1613

ER 1110-2-1404  
EM 1110-2-1613

CHAPTER 4

ENVIRONMENTAL CONSIDERATIONS IN CONSTRUCTION,  
OPERATION, AND MAINTENANCE

4-1. Dredging and Dredged Material Disposal.

a. General. Dredging and dredged material disposal are major activities involved in construction, operation, and maintenance of deep-draft navigation projects. Sediments dredged from new channels consist of material that was deposited by natural processes, often before the appearance of modern man, and may have chemical and engineering properties that create fewer environmental problems than material from maintenance projects. Material removed during maintenance dredging of navigation channels is an accumulation of unconsolidated soil particles that have been transported by wind and water. It is a soil with potential beneficial use. However, material from maintenance dredging may contain a variety of contaminants contributed by man's activities. Equipment selection for dredging is discussed in paragraph 3-5c and EM 1110-2-5025. This section is concerned primarily with dredging and dredged material disposal activities during maintenance of deep-draft navigation projects.

b. Sediment Resuspension During Dredging.

(1) General. There are now ample research results indicating that sediment resuspension during dredging does not result in significant water quality degradation. It has been demonstrated that elevated suspended solids concentrations are generally confined to the immediate vicinity of the dredge and dissipate rapidly at the completion of the operation. However, in cases where sediment resuspension must be minimized, equipment and operational techniques can be selected to meet this requirement. The cutterhead dredge seems to have the least effect on water quality during the dredging operation. This is followed by the hopper dredge, without overflow. When used during overflow periods, the clamshell bucket dredge and hopper dredge can both produce elevated levels of suspended solids in the water column. Sediment resuspension levels during dredging can be reduced by modifying equipment and operating techniques. Both the type of equipment and the operating techniques used with the equipment are important. This section presents some of the commonly used dredges and their potential for causing sediment resuspension during operations.

(2) Cutterhead dredges. The cutterhead dredge is basically a hydraulic suction pipe combined with a "cutterhead" to loosen material that is too consolidated to be removed by suction alone (Figure 4-1). While the properly designed cutterhead will efficiently cut and guide the bottom material toward the suction, the cutting action and turbulence associated with the rotation of the cutterhead will resuspend a portion of the bottom material. Within 10 feet of the cutterhead, suspended solids concentrations are highly variable, but may be as high as 10 to 20 grams per liter. Near-bottom suspended solids concentrations may be elevated to levels of a few hundred milligrams per liter at distances of 1,000 feet from the cutterhead. Factors influencing sediment resuspension during cutterhead dredging include the type of material, thickness of cut, rate of swing, cutterhead rotating speed, and cutterhead design. The shape of the cutterhead also affects the sediment resuspended, particularly if no "over-depth" is allowed. The cutterheads shown in Figure 4-2 have the



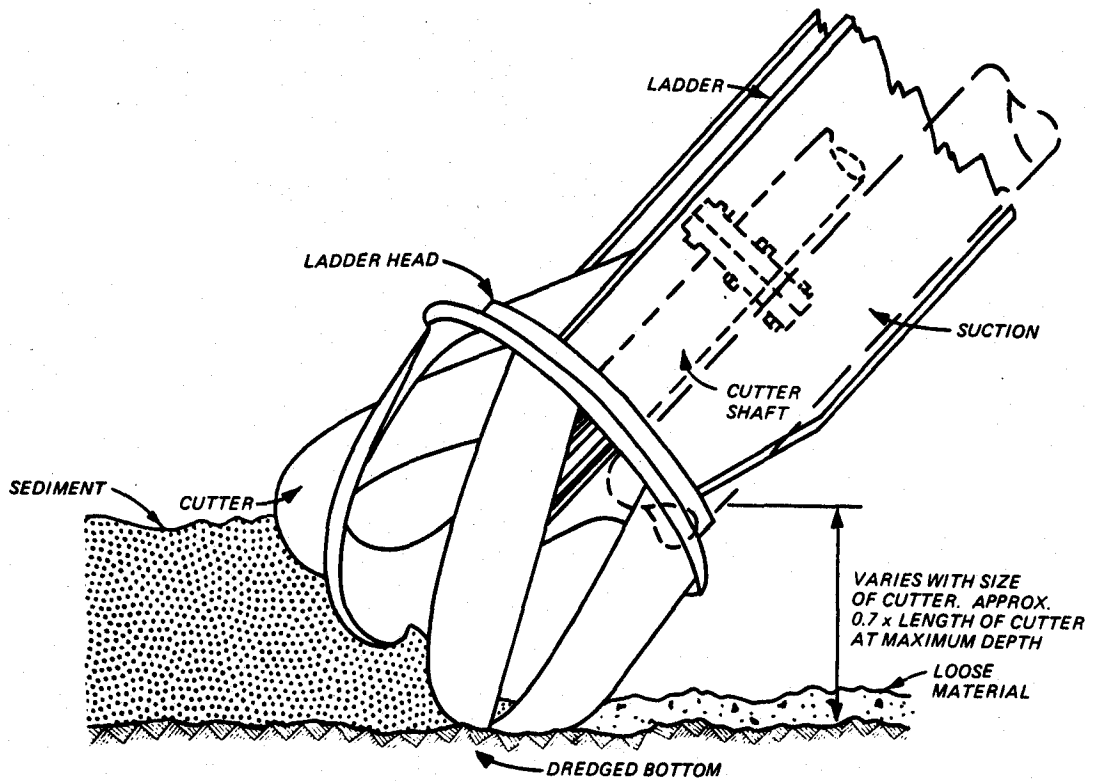

Figure 4-1. Hydraulic cutterhead

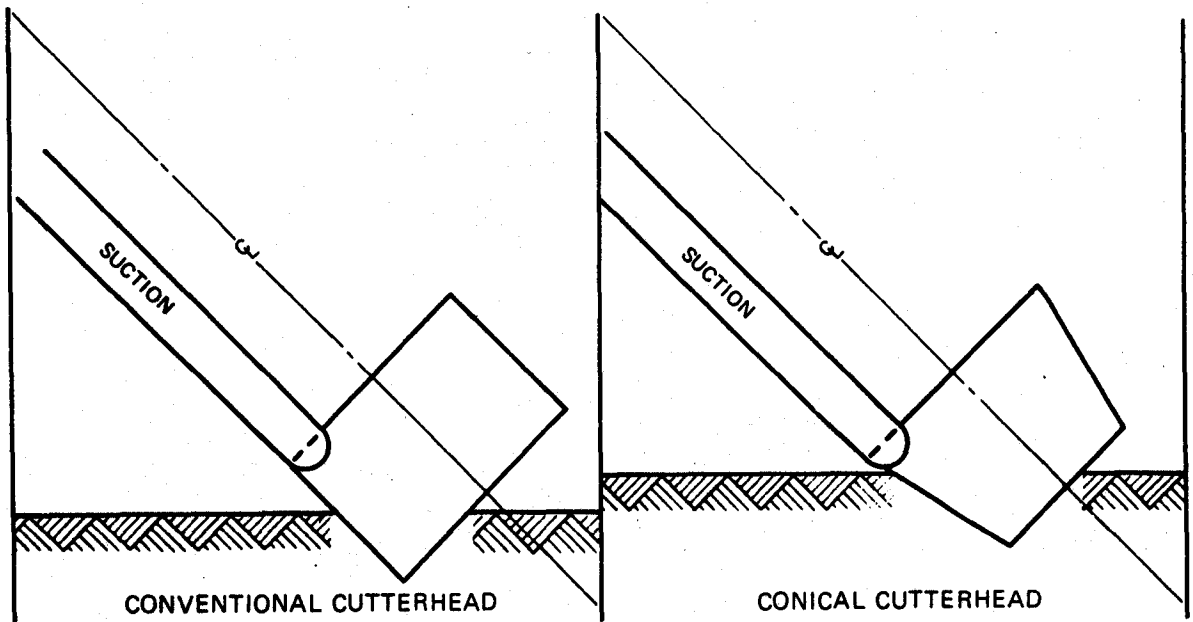

Figure 4-2. Examples of cutterhead designs

same length and base width. They are also depressed to the same angle and are buried to the same depth. However, with the conical-shaped head, the suction is brought closer to the material and the chance of entrainment is improved. This shape difference would be particularly important if the head was not completely buried. The angle  $\alpha$  in Figure 4-3 is called the rake angle. If the rake angle is too large, it will cause a gouging action that will sling soft, fine-grained material outward. If the rake angle is too small, heeling (the striking of the bottom with the heel of the tooth) will occur and increase re-suspension. For fine-grained maintenance-type material, a small rake angle of from 20 to 25 degrees would be best. This would allow a shallow entry that would lift the bottom sediment and guide it toward the suction.

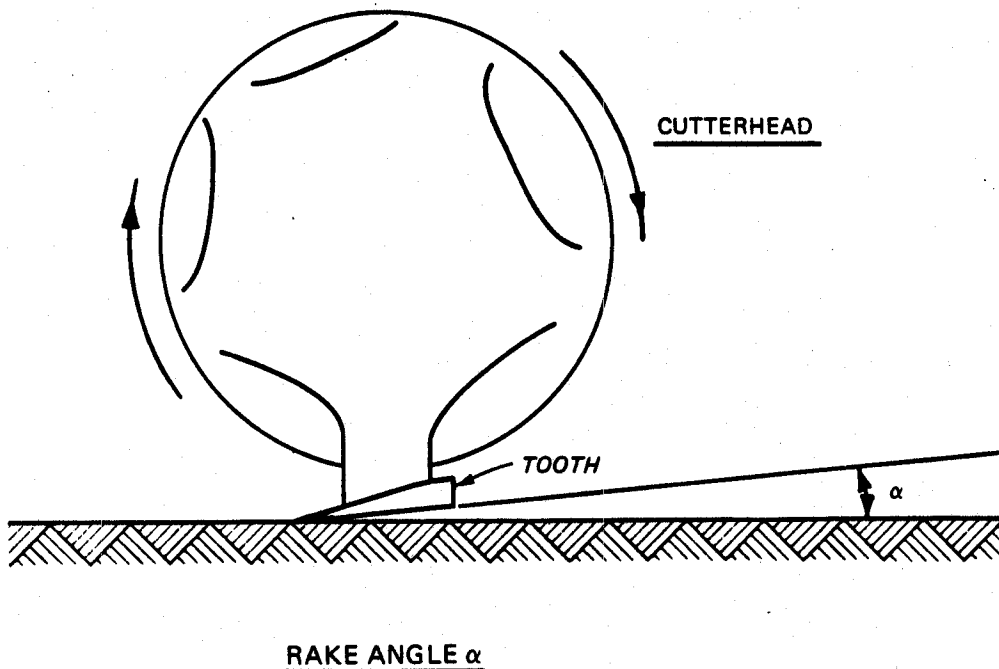

Figure 4-3. Rake angle of cutters on cutterhead

(3) Hopper dredges. Hopper dredges are used mainly for maintenance dredging in deep-draft harbor areas and shipping channels where traffic and operating conditions rule out the use of stationary dredges (Figure 4-4). During filling operations, pumping of the dredged material slurry into the hoppers is often continued after the hoppers have been filled in order to maximize the amount of high-density material in the hopper. The low-density turbid water at the surface of the filled hoppers then overflows and is usually discharged through ports located near the waterline of the dredge. Resuspension of fine-grained maintenance dredged material during hopper dredge operations is caused by the dragheads as they are pulled through the sediment, turbulence generated by the vessel and its prop wash, and overflow of turbid water during hopper-filling operations. Field data confirm that the suspended solids levels generated by a hopper dredge operation are primarily caused by hopper overflow in the near-surface water and draghead resuspension in near-bottom water. In the immediate vicinity of the dredge, a well-defined upper plume is generated by the overflow process and a near-bottom plume by draghead resuspension; 900 to 1200 feet behind the dredges, the two plumes merge into a single plume

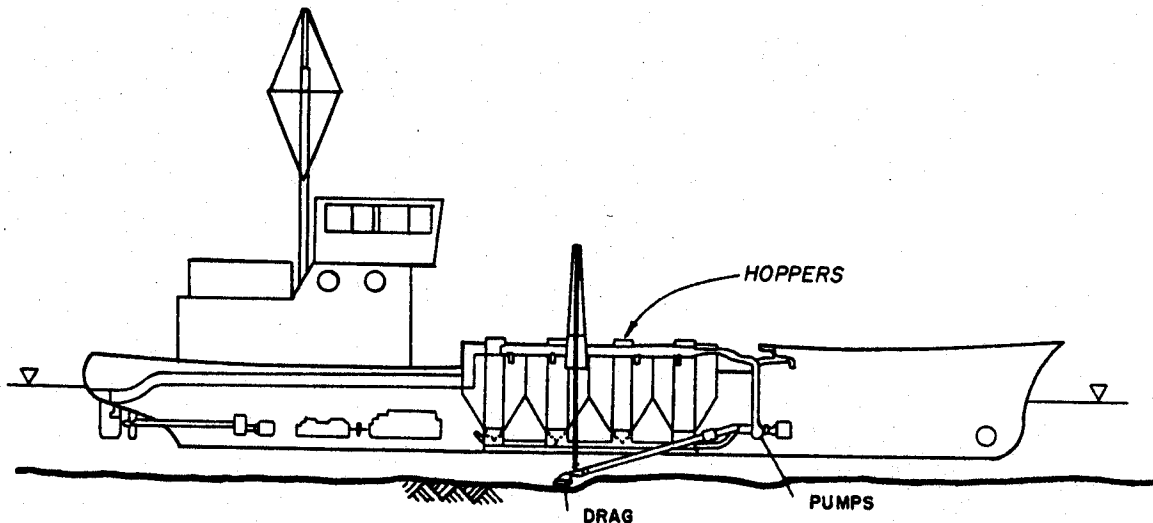

Figure 4-4. Seagoing hopper dredge

(Figure 4-5). As the distance from the dredge increases, the suspended solids concentration in the plume generally decreases, and the plume becomes increasingly limited to the near-bottom waters. Suspended solids concentrations may be as high as several tens of grams per liter near the discharge port and as high as a few grams per liter near the draghead. Suspended sediment levels in the near-surface plume appear to decrease exponentially with increasing distance from the dredge due to settling and dispersion, and the levels quickly reach concentrations of less than one gram per liter. However, plume concentrations may exceed background levels even at distances in excess of 3600 feet. Of the two sources of sediment resuspension from the hopper dredge (the draghead and pumping past overflow), the overflow material produces by far the most sediment resuspension. This source of near surface resuspension can be addressed in several ways. The first is to assess the type of material being dredged and its environmental impact. If the material being dredged is clean sand, the percentage of solids in the overflow will be small, and economic loading may be achieved by pumping past overflow. When contaminated sediments are to be dredged and adverse environmental effects have been identified, pumping past overflow is not recommended. In such cases, other types of dredges may be more suitable for removing the contaminated sediments from the channel prism. In the case of fine-grained materials, the settling properties of silt and clay sediments may be such that only a minimal load increase would be achieved by pumping past overflow.

(4) Bucket dredges. The bucket dredge consists of various types of buckets operated from a crane or derrick mounted on a barge or on land. It is used extensively for removing relatively small volumes of material, particularly around docks and piers or within restricted areas. The sediment removed is a nearly in situ density; however, the production rates are quite low compared with those of a cutterhead dredge, especially in consolidated material. The dredging depth is practically unlimited, but the production rate drops with an increase in depth. The bucket dredge usually leaves an irregular cratered bottom. The resuspension of sediments during bucket dredging is caused primarily by the impact, penetration, and withdrawal of the bucket from the bottom

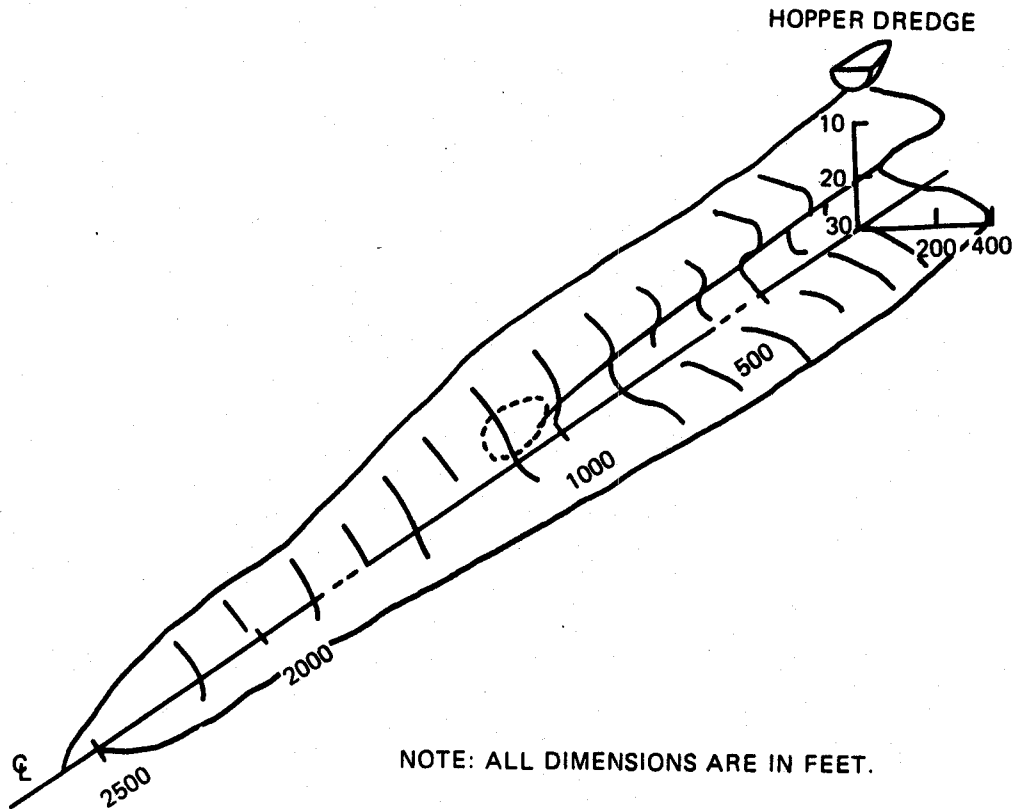

Figure 4-5. Hypothetical suspended solids plume downstream of a hopper dredge

sediments. Secondary causes are loss of material from the bucket as it is pulled through the water, spillage of turbid water from the top and through the jaws of the bucket as it breaks the surface, and inadvertant spillage while dumping (Figure 4-6). Limited field measurements on sediment resuspension caused by bucket dredges showed that the plume downstream of a typical clamshell operation may extend approximately 1000 feet at the surface and 1500 feet near the bottom. It was also observed that the maximum suspended sediment concentration in the immediate vicinity of the dredging operation was less than 500 milligrams per liter and decreased rapidly with distance from the operation due to settling and mixing effects. The major source of turbidity in the lower water column is mainly sediment resuspended at the impact point of the clamshell. Although researchers have reported some reduction in sediment resuspension with the variation of hoist speed and depth of cut, the greatest reduction in resuspension with clamshell dredging came from the use of a so-called "watertight" or enclosed clamshell bucket. The Port and Harbour Institute of Japan developed a watertight bucket with an enclosed top to contain the dredged material within the bucket. A direct comparison of a one-cubic-meter standard open clamshell bucket with a watertight clamshell bucket indicates that watertight buckets generate 30 to 70 percent less resuspension in the water column than open buckets. WES conducted a field test to compare the effectiveness of enclosed clamshell buckets. The resuspension produced by an enclosed 13-cubic-yard bucket (Figure 4-7) was compared with a 12-cubic-yard standard open bucket



Figure 4-6. Spillage from conventional bucket



Figure 4-7. Enclosed 13-cubic-yard clamshell

during dredging of the St. Johns River near Jacksonville, Florida. The results of this test are given in the following tabulation.

<u>Water Column</u>	<u>Radial</u>	<u>Suspended Sediment</u> (mg/l) <sup>1/</sup>		<u>Percent Reduction</u>
		<u>Enclosed</u>	<u>Open</u>	
Upper	1	33.7	76.4	56
	2	27.8	45.8	39
Lower <sup>2/</sup>	1	189.0	84.6	
	2	283.4	85.0	

<sup>1/</sup> Averages adjusted for background suspended solids levels.

<sup>2/</sup> Measurements made within five feet of bottom.

This test revealed a marked reduction (30- to 45-percent reduction) in sediment resuspension in the upper water column with the enclosed bucket. Some drawbacks were also revealed, however. The enclosed bucket produced increased resuspension near the bottom, probably due to a shock wave of water that preceded the watertight bucket because of the enclosed top. Also, both the earlier Japanese and the Jacksonville buckets had rubber gaskets along the cutting edge of the bucket to seal them. This limited the use of the bucket to soft material and trash-free areas.

c. Open-Water Disposal.

(1) General. The three major open-water disposal methods are: (a) hopper dredge discharge, (b) barge disposal, and (c) hydraulic pipeline disposal. These methods are controlled by the selection of a dredge for a specific dredging project. This section deals with the physical aspects of placing dredged material in open-water disposal sites. The following items must be considered when evaluating the open-water disposal alternative:

<u>Item</u>	<u>Information Source</u>
Open-water disposal	EM 1110-2-5025
Water-column turbidity	WES TR DS-78-13
Fluid mud and mounding	WES TR DS-78-13
Turbidity plume models	WES TR DS-78-13 WES TR DS-78-3

(2) Behavior of discharges from hopper dredge. The characteristics and operation of hopper dredges are discussed in EM 1110-2-5025. When the hoppers have been filled as described, the drag arms are raised and the hopper dredge proceeds to the disposal site. At the disposal site, hopper doors in

the bottom of the ship's hull are opened and the entire hopper contents are emptied in a matter of seconds; the dredge then returns to the dredging site to reload. This procedure produces a series of discrete discharges at intervals of perhaps one to several hours. Upon release from the hopper dredge at the disposal site, the dredged material falls through the water column as a well-defined jet of high-density fluid that may contain blocks of solid material (Figure 4-8). Ambient water is entrained during descent. After it hits bottom, some of the dredged material comes to rest, and some spreads horizontally upon bottom impact and is carried away until the turbulence is sufficiently reduced to permit its deposition.

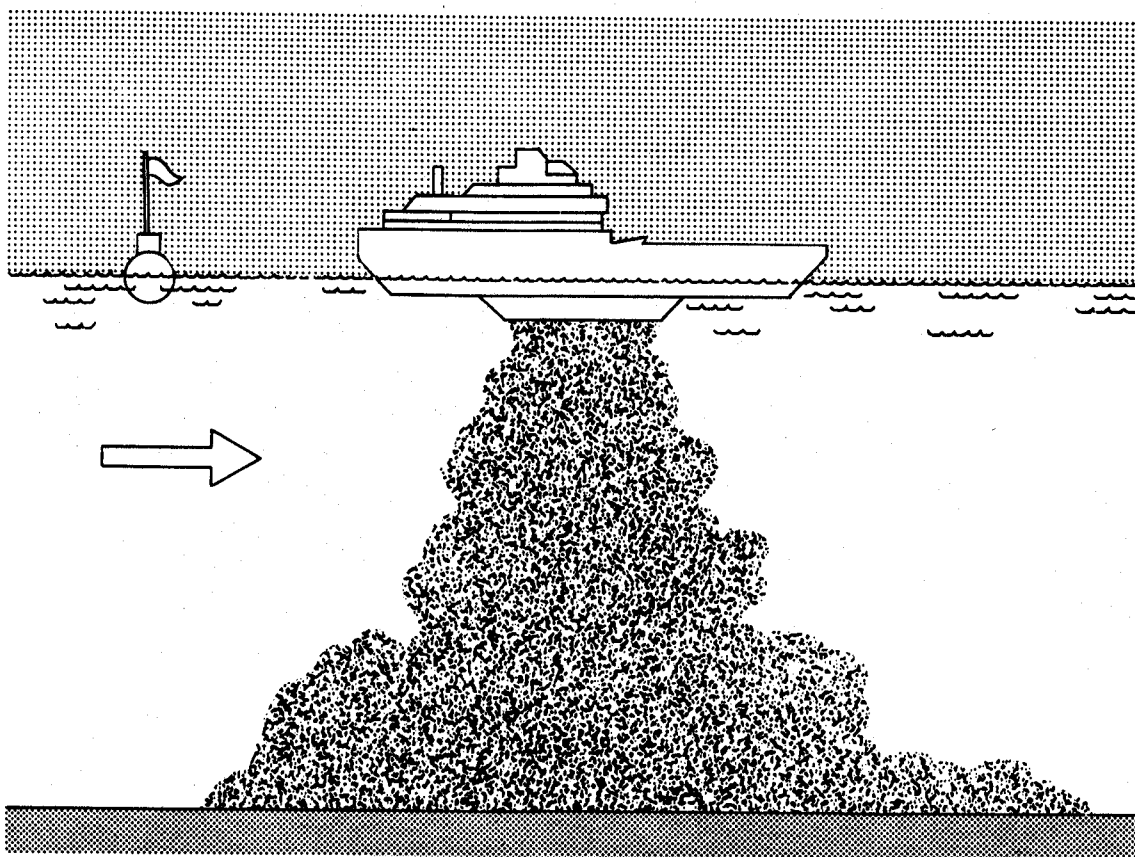

Figure 4-8. Movement of dredged material discharged from a hopper dredge

(3) Behavior of discharges from barge disposal. Bucket dredges remove the sediment being dredged at nearly its in situ density and place it in barges or scows for transportation to the disposal area, as described in EM 1110-2-5025. Although several barges may be used so that the dredging is essentially continuous, disposal occurs as a series of discrete discharges. The dredged material may be a slurry similar to that in a hopper dredge, but often sediments dredged by clamshell remain in fairly large consolidated clumps and reach the bottom in this form. Whatever its form, the dredged material descends rapidly through the water column to the bottom, and only a small amount of the material remains suspended (Figure 4-9).

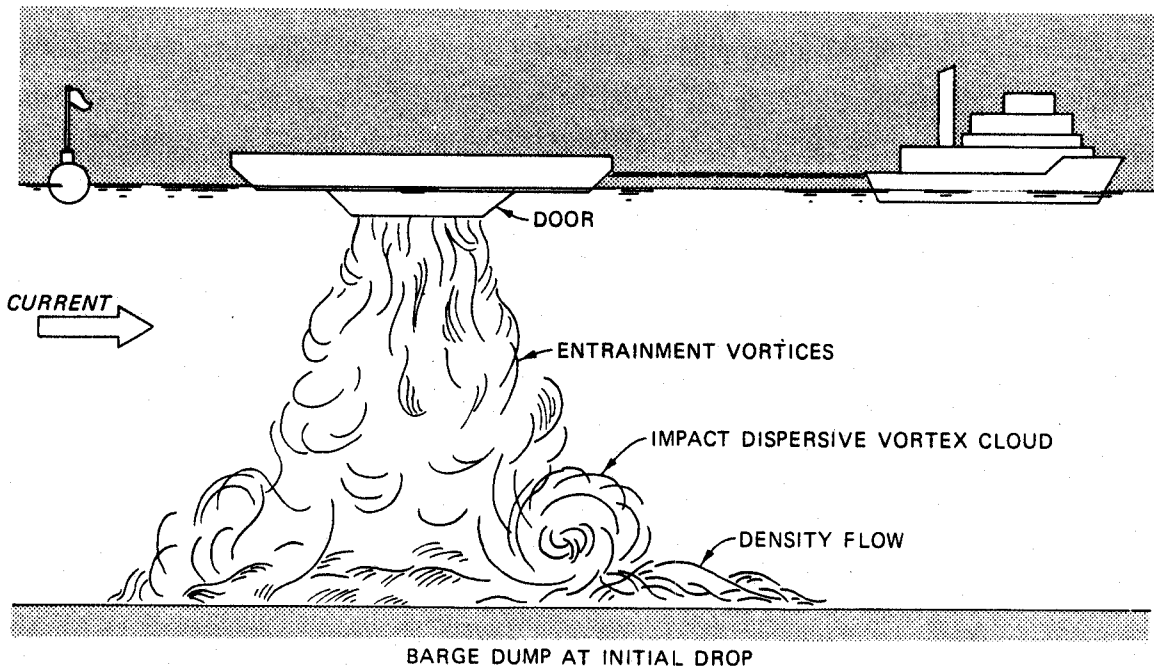

Figure 4-9. Dredged material discharged from a barge

(4) Behavior of hydraulic pipeline discharges. The operation of a cutterhead dredge, described in EM 1110-2-5025, produces a slurry of sediment and water discharged at the disposal site in a continuous stream. As the dredge progresses up the channel, the pipeline is moved periodically to keep abreast of the dredge. The discharged material slurry is generally dispersed in three modes. Any coarse material, such as gravel, clay balls, or coarse sand, will immediately settle to the bottom of the disposal area and usually accumulates directly beneath the discharge point. The vast majority of the fine-grained material in the slurry also descends rapidly to the bottom in a well-defined jet of high-density fluid, where it forms a low-gradient circular or elliptical fluid mud mound. Approximately one to three percent of the discharged material is stripped away from the outside of the slurry jet as it descends through the water column and remains suspended as a turbidity plume (Figure 4-10). During the maintenance dredging of channels located in rivers and estuaries, fine-grained dredged material is typically disposed within designated open-water or side-channel disposal areas located 1000 to 3000 feet from the channel in water depths of 4 to 20 feet. On most large maintenance operations, a cutterhead dredge may be used to excavate the sediment, which is subsequently pumped as a slurry through a pontoon-supported pipeline at velocities of 13 to 20 feet per second to a disposal area adjacent to the channel (Figure 4-10). Due to the variability in depth of cut, rate of swing, and stepping technique used on a particular operation, the dredged material slurry will usually have a highly variable solids content ranging from 0 to 40 percent solids by weight; 15 percent solids by weight is a typical average value. Dissolved oxygen levels in the fine-grained slurry are essentially zero. The end of the pipeline may be either above water or submerged at an angle of 0 to 90 degrees relative to the water surface and may be equipped with a deflector plate. As the dredge advances down the channel, the discharge point is usually



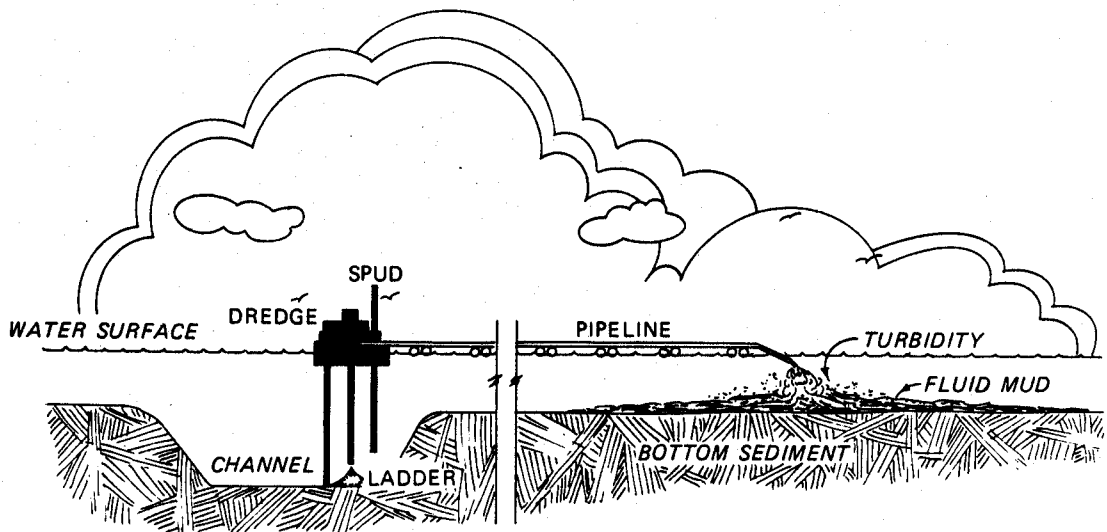

Figure 4-10. Typical channel maintenance dredging operation with open-water pipeline disposal

moved periodically to other disposal areas adjacent to the channel. The dredging operation is normally continuous, but may be interrupted by mechanical breakdown, ship traffic, or bad weather.

d. Confined Dredged Material Disposal.

(1) General. Diked containment areas are used to retain dredged material solids while allowing the carrier water to be released from the containment area. The two purposes of containment areas are: (a) to provide adequate storage capacity to meet dredging requirements, and (b) to attain the highest possible efficiency in retaining solids during the dredging operation in order to meet effluent suspended solids requirements. These considerations are interrelated and depend upon effective design, operation, and management of the containment area. Basic guidelines for design, operation, and management of containment areas are presented in WES TR DS-78-10. Confined disposal of contaminated sediments must be planned to contain potentially toxic materials to control or minimize potential environmental impacts (Figure 4-11). Four major mechanisms for transport of contaminants from upland disposal areas have been identified:

- (a) Release of contaminants in the effluent during disposal operations.
- (b) Leaching into ground water.
- (c) Surface runoff of contaminants in either dissolved or suspended particulate form following disposal.
- (d) Plant uptake directly from sediments, followed by indirect animal uptake from feeding on vegetation.

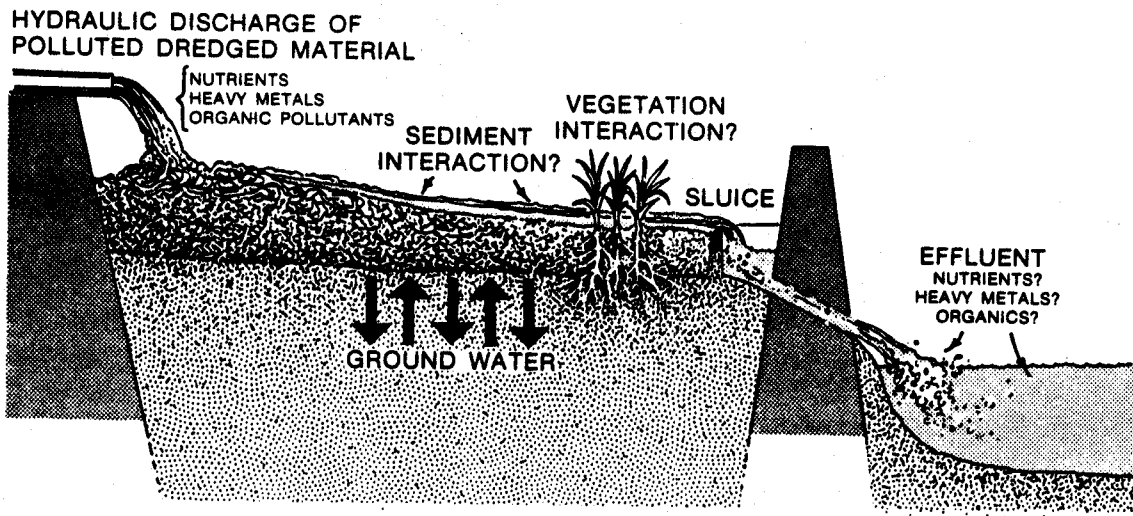

Figure 4-11. Confined disposal area effluent and leachate control

(2) Containment area design. The major components of a dredged material containment area are shown schematically in Figure 4-12. A tract of land is surrounded by dikes to form a confined surface area into which dredged channel sediments are pumped hydraulically. In some dredging operations, especially in the case of new-work dredging, sand, clay balls, and/or gravel may be present. This coarse material rapidly falls out of suspension and forms a mound near the dredge inlet pipe. The fine-grained material (silt and clay) continues to flow through the containment area where most of the solids settle out of suspension and thereby occupy a given storage volume. The fine-grained dredged material is usually rather homogeneous and is easily characterized. The clarified water is discharged from the containment area over a weir. This effluent can be characterized by its suspended solids concentration and rate of outflow. Effluent flow rate is approximately equal to influent flow rate for a continuously operating disposal area. To promote effective sedimentation, ponded water is maintained in the area; the depth of water is controlled by the elevation of the weir crest. The thickness of the dredged material layer

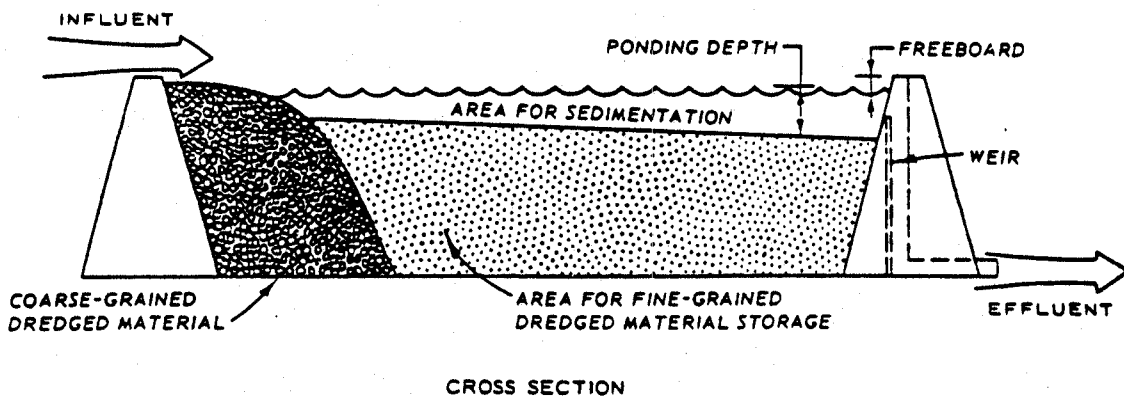

Figure 4-12. Schematic of a dredged material containment area

increases with time until the dredging operation is completed. Minimum free-board requirements and mounding of coarse-grained material result in a ponded surface area smaller than the total surface area enclosed by the dikes. In most cases, confined disposal areas must be utilized over a period of many years, storing material dredged periodically over the design life. Long-term storage capacity for these sites is influenced by consolidation of dredged material and foundation soils, dewatering of material, and effective management of the disposal area. The following steps should be used for containment area design:

<u>Step</u>	<u>Information Source</u>
Evaluate dredging activities	WES TR DS-78-10
Perform field investigations	WES TR DS-78-10
Perform laboratory investigations	WES TR DS-78-10
Design methods for storage and retention of suspended solids	WES TR DS-78-10
Evaluate long-term storage requirements	WES TR DS-78-10
Design weirs	WES TR DS-78-10
Evaluate chemical clarification requirements	WES TR DS-83-2
Design retaining dikes	WES TR D-77-9

(3) Containment area operation and management.

(a) A major consideration in proper containment area operation is providing the ponding necessary for sedimentation and retention of suspended solids. Adequate ponding depth during the dredging operation is maintained by controlling the weir crest elevation, usually by placing boards within the weir structure. Before dredging commences, the weir should be boarded to the highest possible elevation that dike stability considerations will allow. This practice will ensure maximum possible efficiency of the containment area. The maximum elevation must allow for adequate ponding depth above the highest expected level of accumulated settled solids and yet remain below the required freeboard. If the basin is undersized or if inefficient settling is occurring in the basin, it is necessary to increase detention time and reduce approach velocity to achieve efficient settling and to avoid resuspension, respectively. Detention time can be increased by raising the weir crest to its highest elevation to increase the ponding depth; it may also be increased by operating the dredge intermittently to maintain a maximum allowable static head or depth of flow over the weir, based on the effluent quality achieved at various weir crest elevations. Once the dredging operation is completed, the ponded water must be removed to promote drying and consolidation of dredged material. (WES TR DS-78-10 provides detailed guidance.)

29 May 87

(b) The importance of periodic site inspections and continuous site management following the dredging operation cannot be overemphasized. Once the dredging operation has been completed and the ponded water has been decanted, site management efforts should be concentrated on maximizing the containment storage capacity gained from continued drying and consolidation of dredged material and foundation soils. To ensure that precipitation does not pond water, the weir crest elevation must be kept at levels allowing efficient release of runoff water. This will require periodic lowering of the weir crest elevation as the dredged material surface settles. Gains in long-term storage capacity of containment areas through natural drying processes can also be increased by placing the dredged material in thin lifts. Thin-lift placement greatly increases potential capacity through active dewatering and disposal area reuse management programs. Thin-lift placement can be achieved by obtaining sufficient land area to ensure adequate storage capacity without the need for thick lifts. It requires careful long-range planning to ensure that the large land area is used effectively for dredged material dewatering, rather than simply being a containment area whose service life is longer than that of a smaller area. Dividing a large containment area into several compartments can facilitate management; each compartment can be managed separately so that some compartments are being filled while the dredged material in others is being dewatered. (WES TR DS-78-11 provides detailed guidance.)

e. Habitat Development.

(1) General. Habitat development refers to the establishment of relatively permanent and biologically productive plant and animal habitats. The use of dredged material as a substrate for habitat development offers a disposal technique that is, in many situations, a feasible alternative compared with more conventional open-water, wetland, or confined disposal options. Four general habitats are suitable for establishment on dredged material: marsh, upland, island, and aquatic. Within any habitat, several distinct biological communities may occur. The determination of the feasibility of habitat development will center on the nature of the surrounding biological communities, nature of the dredged material, site selection, frequency with which the site will be used, engineering design, cost of alternatives, environmental impacts, and public approval. If habitat development is the selected alternative, a decision regarding the type or types of habitats to be developed must be made; in general, site peculiarities will usually allow only one or two logical options. References that should be consulted for information on habitat development include:

<u>Item</u>	<u>Information Source</u>
Marsh development	WES TR DS-78-16
Upland habitat	WES TR DS-78-17
Island habitat	WES TR DS-78-18
Aquatic habitat	WES, Environmental Laboratory

29 May 87

(2) Marsh habitat. Marshes are considered to be any community of grasses and/or herbs that experiences periodic or permanent inundation. Typically, these are intertidal fresh, brackish, or salt marshes or relatively permanently inundated freshwater marshes. Marshes are often recognized as extremely valuable natural systems and are accorded importance in food and detrital production, fish and wildlife cover, nutrient cycling, erosion control, floodwater retention, ground-water recharge, and aesthetic value. Marsh values are highly site specific and must be interpreted in terms of such variables as plant species composition, wildlife use, location, and size, which in turn influence their impact upon a given ecosystem. Marsh development has been the most studied of the habitat development alternatives, and accurate techniques have been developed to estimate costs and to design, construct, and maintain these systems. Over 100 marshes have been established on dredged material. The advantages most frequently identified with marsh development are: considerable public appeal, creation of desirable biological communities, considerable potential for enhancement or mitigation, and, frequently, low cost.

(3) Upland habitat. Two situations have potential for upland habitat development. In one, an existing disposal area can be reclaimed or increased in value with a given level of effort. In the other, dredged material disposal from a dredging project will occur at a selected site, and disposal can be planned to meet a habitat goal. The site may be selected for suitability and potential after eliminating alternative sites, but in many cases the choice will be limited and planning will involve making the best of a less than optimum situation. Information provided in WES TR DS-78-17 applies to both situations, with the exception of the steps that deal with the actual disposal process and apply to an active project. It is assumed, in the case of an active dredging project, that habitat development has been selected as the alternative for dredged material disposal. Figure 4-13 outlines procedural guidelines for selection of upland habitat development projects.

(4) Island habitat. Dredged material islands range in size from an acre to several hundred acres. Island habitats are terrestrial communities completely surrounded by water or wetlands and are distinguished by their isolation and their limited food and cover. Because they are isolated and relatively predator free, they have particular value as nesting and roosting sites for numerous species of sea and wading birds, e.g., gulls, terns, egrets, herons, and pelicans. The importance of dredged material islands to nesting species tends to decrease as the size increases because larger islands are more likely to support resident predators. However, isolation is more important than size; thus, large isolated islands may be very attractive to nesting birds. Dredged material islands are found in low- to medium-energy sites throughout the United States. Typically, these are sandy islands located adjacent to navigation channels and are characteristic of the Intracoastal Waterway. In recent years, many active dredged material islands have been diked to improve containment characteristics of the sites.

(5) Aquatic habitats. Aquatic habitat development refers to the establishment of biological communities on dredged material at or below mean tide. Potential developments include such communities as tidal flats, seagrass meadows, oyster beds, and clam flats. The bottoms of many water bodies could be altered using dredged material; in many cases this would simultaneously

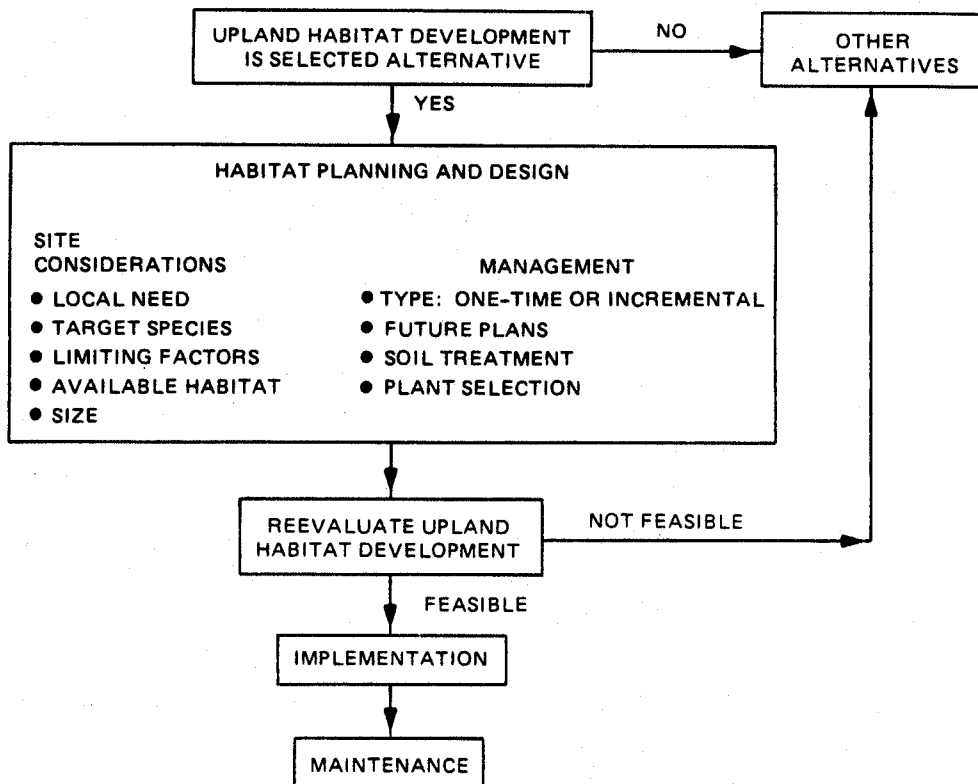

Figure 4-13. Outline of procedural guidelines for selection of upland habitat development projects

improve the characteristics of the site for selected species and permit the disposal of significant quantities of material. Planned aquatic habitat development is a relatively new and rapidly moving field of study; however, with the exception of many unintentional occurrences and several small-scale demonstration projects, this alternative is largely untested. No general texts or manuals are currently available; however, potential users may obtain updated information by contacting the Environmental Laboratory at the WES.

4-2. Navigation Traffic. Possible means to alleviate adverse environmental effects of navigation traffic include:

- a. Encouraging pilots to keep vessels within the normal navigational channel.
- b. Setting up established fleeting areas for commercial traffic.
- c. Maintaining environmentally sensitive areas (e.g. fish nursery areas or riverine areas near heron rookeries) off limits to traffic.
- d. Restricting the speed, horsepower, and/or frequency of boat traffic. Table 4-1 depicts the relationships among vessel and wave parameters.
- e. If habitat destruction due to vessel-caused wave erosion is a problem, structures (paragraph 3-4) to protect environmentally sensitive areas

Table 4-1. Typical Waves from Representative Vessels\*

<u>Vessel</u>	<u>Speed ft/sec</u>	<u>Length feet</u>	<u>Draft feet</u>	<u>Breadth feet</u>	<u>Gross tonnage</u>	<u>Draw- down feet</u>	<u>Wave Height feet</u>
UP							
1	16.0	690	29	85	25,600	1.0	0.75
2	18.6	465	29	60	5,900	0.5	1.0
3	14.8	537	29	69	11,300	1.0	0.5
4	13.0	297	18	43	2,000	0.75	1.5
5	17.5	505	28	62	9,000	0.5	0.5
6	21.0	400	20	52	3,100	0.25	1.5
7	16.0	730	27	75	15,700	1.25	0.75
8	18.7	467	28	63	8,500	0.75	1.5
9	14.0	523	27	68	10,600	1.0	0.75
10	19.7	412	25	60	5,100	0.75	1.0
11	19.0	500	28	63	7,700	1.00	1.5
DOWN							
12	25.5	608	29	80	23,000	3.0	1.0
13	27.0	374	24	51	4,500	0.75	1.5
14	23.0	519	30	65	10,800	0.75	0.75
15	24.0	516	27	65	7,300	0.5	1.0
16	24.0	291	19	45	2,500	0.5	1.25
17	28.0	467	28	59	8,200	1.0	2.5
18	25.0	608	29	80	22,000	2.5	1.5

ft/sec	10	12	14	16	18	20	22	24	26	28	30
knots	5.9	7.1	8.3	9.5	10.7	11.8	13.0	14.2	15.4	16.6	17.8

\* Distance to sailing line approximately 700 feet.  
Source: Hurst and Brenner (1969).

such as shorelines and marshes may be evaluated. (Hurst and Brenner (1969), Mulvihill et al. (1980), and Schnick et al. (1982) provide more detailed information.)

f. Maintaining traffic inside the navigational channel and keeping selected areas off limits are both feasible but would involve the cooperation of several agencies and groups.

g. Presently, the best means to improve navigation effects would be to maintain habitat diversity and to protect productive habitats, as discussed in paragraph 3-4.

## CHAPTER 5

### ENVIRONMENTAL DATA COLLECTION AND ANALYSIS

5-1. General Considerations. In the process of planning and designing deep-draft navigation projects, assessment of potential environmental impacts must be made. This assessment is done through very detailed and site-specific data collection and evaluation efforts. However, there are basic requirements which are common to all data collection programs. This chapter outlines the general aspects to be considered when undertaking an environmental data collection program.

a. Problem Identification. Before objectives for a data collection effort are set, the problem to be addressed must be clearly identified. The general (and sometimes specific) nature of the problem may be ascertained from a variety of sources. These include EIS's, General Design Memorandums (GDM's), consent decrees, statutes, regulations, and interagency agreements. When a problem is identified, the initial step is to determine if it is amenable to analysis. Two determinations are involved in this process: first, if the means to obtain and/or analyze data exist (if not, the problem obviously cannot be investigated); and second, the cost and length of time required to obtain and analyze the data.

b. Setting Objectives.

(1) Need for objectives. The most essential part of an environmental data collection and analysis effort is the establishment of clear and concise objectives. If this is not done, the net result is often either an inability to solve the problem for which the data were generated, or a mass of data that defies rational analysis. Without good objectives, any data collection/analysis effort faces a high probability of failure.

(2) Nature of objectives. A well-written objective helps define specific actions or activities to address when a specific aspect of the issue is being investigated. It places bounds on the work to be done, excluding nonapplicable or unnecessary efforts. Wording of an objective should be clear, unambiguous, concise, and simple. An objective must be realistic and therefore attainable, oriented in a positive direction with no unproductive branching, and measurable to allow evaluation of progress and results.

c. Experimental/Study Design. When the nature of the data to be collected has been determined, attention is then directed to design of the experiment or study. The design is used to determine how the objectives will be met and includes decisions on parameter and variable selection, data collection methods, study milestones, resource allocation, and necessary reports. Use of CPM (Critical Path Method) logic networks is often helpful in outlining work to be accomplished and the sequence. The depth and detail of study should be comparable to other study elements in the current stage of planning or engineering, and consistent with the overall project scope.

d. Type of Data. There are two basic kinds of data: qualitative and quantitative. The former are subjective and nonnumerical, while the latter are objective and numerical. A qualitative approach to data collection may be



29 May 87

called for if only descriptive data are required, the study is preliminary in nature, quality of previous data is poor, or a short suspense has been set. A quantitative approach is preferable because it can be expressed as a testable hypothesis. It is often useful to express the hypothesis as a question, for example, "Will (has) the project increase(d) (decrease(d)) some variable?" The objective of data collection then essentially becomes the verification or rejection of a hypothesis.

e. Documentation. Documentation of study/experiment findings is critical to the future use of the environmental data collected. Reporting requirements should be incorporated into the experimental design, taking into consideration the report format to be used. A common format used in reports of experimental data is given below:

(1) Introduction. This portion should contain background information and state the nature of the problem and how specific objectives will lead to resolving the problem.

(2) Materials and methods. This portion should consist of detailed field and laboratory procedures, place, time, number of samples to be taken, and methods to be used to analyze the data (test the hypothesis).

(3) Results. Measurements of variables and results of hypothesis testing should be given here. If extensive data are obtained, summary values should be given in this section with actual measurements provided as an appendix, on microfiche or on computer tape.

(4) Discussion. The significance of the results to meeting the study objectives should be set forth, together with qualifications and/or explanations.

(5) Conclusion. If the first four sections of the documentation are properly executed, one of three conclusions is probable. The first is that no problem actually exists; if so, no additional action is required. The second possible conclusion is verification of the problem as stated in the introduction. In this case, an additional section (Recommendations) is needed in the report to suggest means of avoiding, reducing, ameliorating, or mitigating the problem. A third possible conclusion is that additional data collection is required to properly address the objective.

f. Summary. The collection of environmental data for Corps water resource projects consists of several distinct steps, as outlined in Figure 5-1. The first is problem identification; this leads to the definition of objectives, which preferably involve quantitative data amenable to statistical evaluation. Definition of objectives is followed by experiment/study design and collection, analysis, and evaluation of data. Finally, the conclusions are referenced to the objectives and, if needed, appropriate recommendations are given. Findings are reported or presented in an appropriate form.

## 5-2. Monitoring Program

a. Purpose. Monitoring refers generally to the repetitive collection of data to evaluate changes and trends. Monitoring includes the overall process

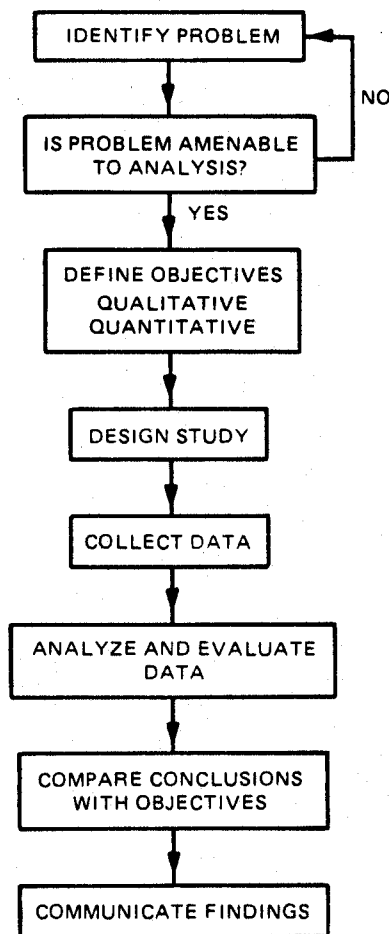

Figure 5-1. Major steps in conducting environmental studies

of data collection, analysis, and interpretation of immediate short-term or long-term changes associated with a project, and may be conducted over the life of the project. Environmental monitoring is usually conducted for one of two purposes, as described below.

(1) Monitoring activities are used to evaluate predictions from the planning phase and guide any necessary remedial work. These predictions are often found in the project EIS and relate to changes expected to result from the project. Before and after measurements are then compared to establish the accuracy of prediction (model). If a predicted change does not occur, or if an unexpected change does occur, this is an indication the predictor (model) is faulty. Although the monitored predictions cannot be redone for the existing project or activity being monitored, future predictive procedures can be improved.

(2) Monitoring is also used to determine if project operation meets water quality or other environmental standards. Coordination with other agencies or groups and examination of the EIS and legal requirements (consent

decrees, stipulations, rules and regulations, etc.) will usually reveal areas in which monitoring is desirable. Monitoring should be limited to parameters that provide information about issues of genuine concern.

b. Controls. Monitoring program design should provide for adequate controls. Data on baseline conditions serve as a temporal control, and reference site data serve as a spatial control.

(1) The baseline. A set of baseline data is required to measure change. By definition, baseline data must be collected prior to the construction, dredging, or other environmental disturbances of interest.

(2) Reference site. A reference site representative of without-project conditions at the project site should be included in the monitoring program if at all possible. The purpose of the reference site is to evaluate changes that occur through time but are not related to the project. Without a reference it is often very difficult to establish that observed changes are project related, and a question may remain as to whether natural variability or other perturbations were responsible for observed changes. In some cases it may be possible to control for other perturbations by establishing more than one reference site, as shown in Figure 5-2.

c. Quantitative Data. For scientifically and legally defensible conclusions, baseline monitoring and reference data should be quantitative and the experimental design such that hypotheses concerning change can be statistically evaluated. Quantitative data sufficient for application of statistical tests are often quite expensive, a fact which underlines the importance of careful selection of parameters for measurement.

d. Remedial Action. The monitoring program design should include consideration of potential remedial action. If a desirable change does not occur or if an undesirable change is detected, this information is of little worth unless a remedy is provided. Of course, should predicted change not occur or unexpected change be observed, it is an indication that the predictive procedure was faulty. In such a case, this can serve as a useful feedback mechanism to modify and improve the predictive procedure; this can avoid the repetition of error in the future.

e. Example. A simple hypothetical example will serve to illustrate the principles stated above. It was predicted that a Corps project would result in an increase of the numbers of frecklebelly madtom, an endangered fish species. This prediction was based upon knowledge of the environmental requirements of the frecklebelly madtom; the current (preproject) habitat conditions were marginal, and the project was expected to transform these conditions to a more favorable situation.

(1) Baseline data. Prior to construction, the project manager initiated studies to establish baseline conditions of those physical, chemical, and biological variables influencing the frecklebelly madtom and conducted detailed population estimates in the project area as well as in adjacent and very similar (reference) areas. These studies were conducted over a five-year period to take natural variability into account.

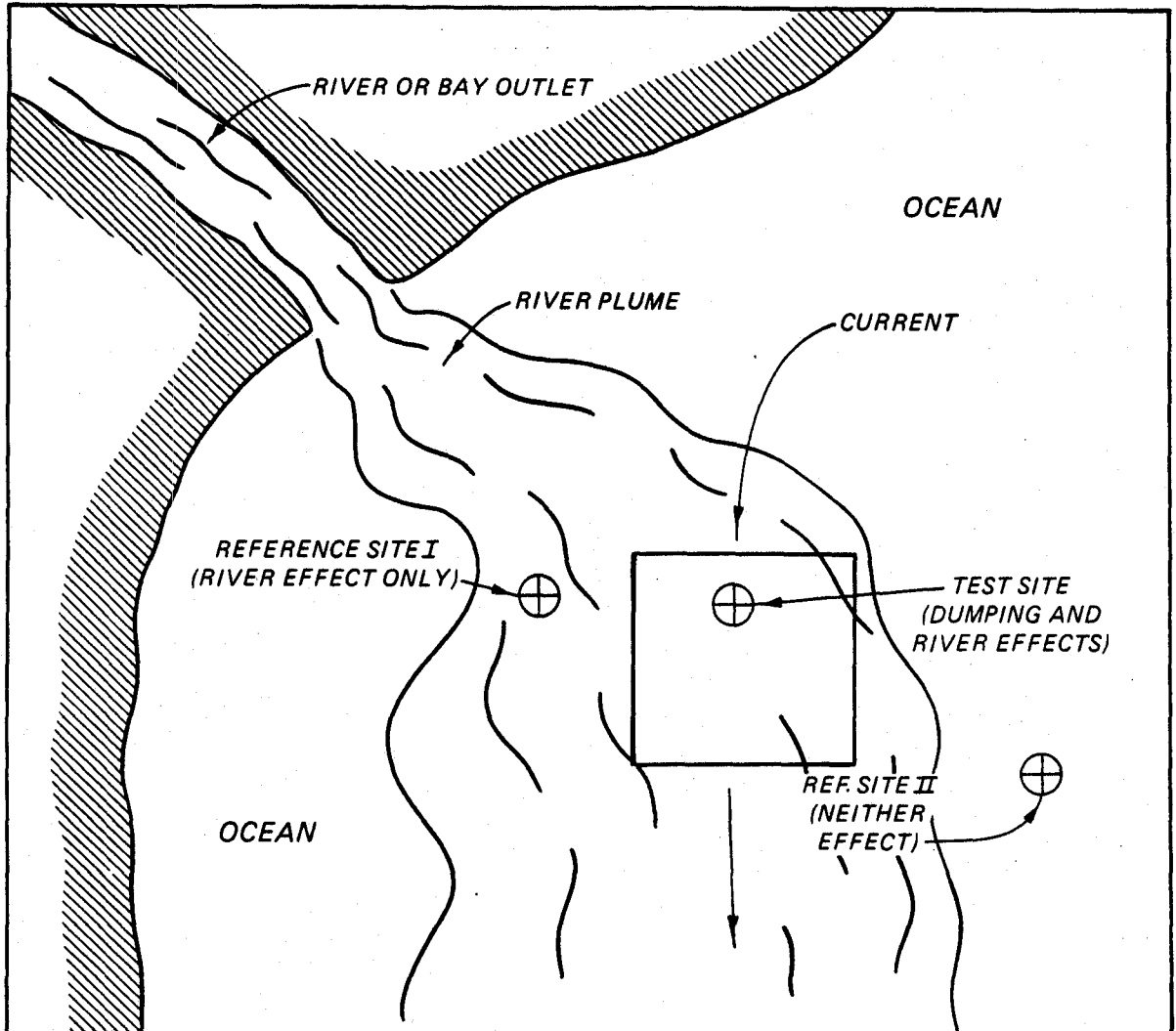

Figure 5-2. Diagram showing two reference sites and monitoring site for a case where a polluted river flows over a dredged material disposal site. Reference site I is control for the test site since the tested variable difference is the dumping. Reference site II is the control for the reference site where the test variable is the polluted riverflow in the ocean.

(2) Monitoring program. Upon project completion, the monitoring program began. Data were obtained for physical, chemical, and biological variables, and population estimates were made of the frecklebelly madtom in the project and reference area. After three years (once again to account for natural variability), it was found that the frecklebelly madtom population in the project area had doubled since construction, but there was no significant change in the reference area population.

(3) Analysis. As there was no change in the reference area population, it was concluded that the predicted change had occurred and had resulted from the project. If there had been a decrease of frecklebelly madtoms in the

29 May 87

project area, the cause of the decrease would have been evaluated by comparison with the reference. If frecklebelly madtom declined or vanished from both project and reference areas, it would indicate that factors other than the project were influencing the population. If populations decreased in the project area but remained stable in the reference area, it would indicate that the predictions were deficient or that the reference area was inappropriate.

5-3. Data Collection. This section provides general guidance necessary to plan an environmental monitoring program that will meet stated objectives of the experimental design. The most critical aspect of data collection is selecting proper parameters to sample and measure in order to answer or solve identified problems.

a. Primary Consideration. The quality of the information obtained through the sampling process is dependent upon: (1) collecting representative samples, (2) using appropriate sampling techniques, and (3) protecting the samples until they are analyzed (sample preservation). Other factors impacting on sampling process are time, costs, and equipment constraints, which will limit the amount of information that can be gathered. Under such conditions, careful tailoring of the monitoring program is required.

b. Quality Control. An effective quality control program must be an integral part of a project from the initial planning for field sampling, through completion of the activity. During the initial meeting, which should include coordination with laboratory and field personnel, the field crew should be made aware of the fact that chemical changes can occur following collection of samples; they should also know how to handle the samples to minimize or prevent these changes. At the same time, laboratory personnel should be reminded of their responsibility to complete the required analysis within the specified time period. A complete quality control program should emphasize sample handling techniques. This is necessary because the greatest potential for sample deterioration and/or contamination occurs during the preanalysis steps of sample collection, handling, preservation, and storage. These problems can be minimized by following prescribed sample handling techniques.

c. Representative Sampling. The purpose of collecting samples is to define physical/chemical characteristics of the project area environment. To do so requires that samples be taken from locations which are typical of ambient conditions found at the project site. Failure to obtain samples that are truly representative of a given location will result in inaccurate data and misinterpretations.

d. Sampling Site Selection and Location.

(1) General. The following factors should be involved in sampling site selection:

- (a) Objectives of the study.
- (b) Accessibility of the site by personnel and equipment.
- (c) Flows (consider extremes of flow, duration, and velocity).

- (d) Mixing.
- (e) Source locations.
- (f) Available personnel and facilities.
- (g) Other physical characteristics.

(2) Sampling locations and parameters to be evaluated. The decision on sampling locations must consider point and nonpoint sources in the project area, and factors that could be critical to the parameter distribution pattern. Primary station locations will depend upon the specific site characteristics and the sampling objectives. Because of this, no firm guidance can be given on the number of sampling stations that should be established. Knowledge of point sources can provide a basis for selecting the parameters for which analyses should be completed. In addition, an evaluation of land use activities in the area can provide an indication of nonpoint contaminants and also contribute to the determination of parameters to be included in the analysis.

(3) References and controls. An additional factor that should be included in establishing a sampling program is the selection of a reference station and/or a control station. Data from a reference or control station are required for comparisons of before, during, and after project construction.

(4) Sampling guidance. The following general guidance is offered as an aid in establishing a biological/sediment sampling program.

(a) Sampling stations should be located downstream from major point sources in the project area. These sources may be selected based on specific constituents in the effluent or on the volume of the discharge. It is usually possible to define these sources based on a knowledge of the activity in the area or a review of historical data for the site.

(b) Additional sampling stations should be located in areas of low hydrologic activity or energy. The reason for sampling these locations is that the lower energy favors the settling of smaller sized suspended particulate matter. This material, due to the greater surface area per unit weight of particulate matter, tends to have higher concentrations of associated chemical contaminants. Suggested locations are:

- 1 On the outside bend of channels.
- 2 In backwater areas or side channels.
- 3 In areas of heavy shoaling or deposition.

However, sampling in these areas may produce sample results that are biased high, and may not be representative of the concentrations in the project area. That is, if primary sampling locations are located in these areas, the concentrations would be expected to be higher than at a more remote project site, and caution should be exercised when trying to extrapolate conclusions from these samples to the entire project area.

29 May 87

(c) Sampling stations should be located in other areas not described in the two categories above. As mentioned previously, sampling below major point sources and in areas of settling to define the maximum concentration that will be found in the sediments of the project area may produce non-representative samples. Therefore, in order to provide a representative idea of contaminant concentration and distribution, samples should also be collected at random locations removed or upstream from major point sources and in areas of higher hydraulic energy (i.e., inside bends of channels). In this way, data obtained from sample analysis will provide information on the range of sediment properties and compositions that can be expected, and the entire set of resultant data will be more representative of the project area. The number of sampling stations located in such areas should be equivalent to the number of stations in categories 1 and 2 of subparagraph (b) above.

(d) If a control area or a former disposal site is to be sampled for comparative purposes, multiple stations should be sampled. Sample composition from these areas will also be variable and cannot be defined based on a single sample.

e. Number of Samples. Guidance in this section is limited to general concepts. First, the greater the number of samples collected, the better the conditions will be defined. Second, the mean of a series of replicated measurements is generally less variable than a series of individual measurements. Third, statistics generally require two characteristics, usually mean and standard deviation, because single measurements are inadequate to describe a sample. Fourth, the necessary number of samples is proportional to the source heterogeneity.

(1) Consideration of the above factors suggests that replicate samples should be collected at each location and that a minimum of three replicates are required to calculate standard deviations. Beyond the replication at a single point, the factors listed above do not limit the number of samples needed since it depends on site-specific heterogeneity (distribution pattern) and the desired level of source definition (degree of precision). The total number of samples is controlled by the type of sampling pattern selected (random, cluster, uniform) (see Figure 5-3). (Additional information regarding number of samples is given in Elliott (1977), Green (1979), and Snedecor and Cochran (1967).)

(2) A rapid method for determining the number of samples necessary when investigating a biological population is to calculate the cumulative mean of a few samples obtained in a pilot survey. A cumulative mean (or running average) consists of taking the average of samples 1 and 2; then of samples 1, 2, and 3 (first, second, and third, etc.); then of samples 1, 2, 3, and 4 (and so on), until all samples have been included. If the results are displayed (see Figure 5-4), the plot of mean values will stabilize as more and more samples are included. In populations with a random distribution (when the variability is fairly low), the mean stabilizes quickly (see Table 5-1). In the cluster distribution (Table 5-2), the variation is quite high and the total cumulative mean stabilizes slowly. In the example given in Table 5-1, the random distribution stabilizes at about 8 or 10 samples. In the cluster distribution pattern, the line never stops fluctuating, although as can be seen in Table 5-2, after about 15 samples the data begin to stabilize.

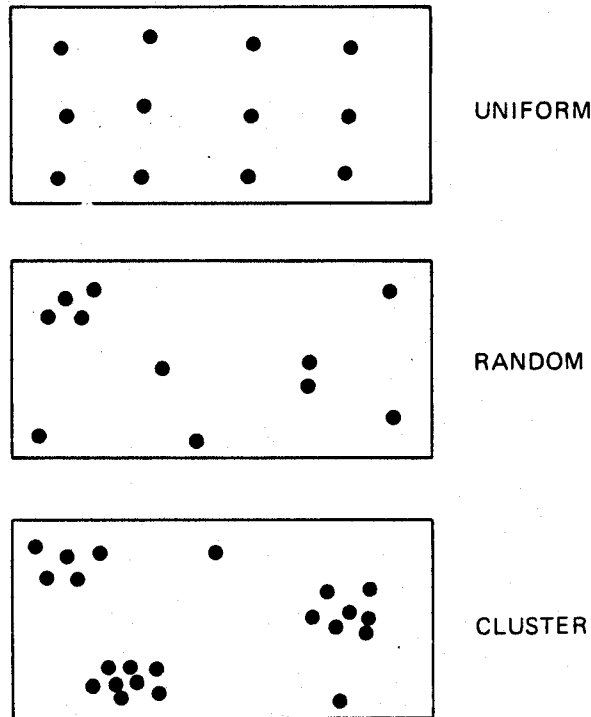

Figure 5-3. Three possible distribution patterns

(3) A more sophisticated technique is described by Green (1979). A preliminary or pilot survey is taken from the population, and individual counts are made from each collection to calculate the sample mean and standard deviation. The formula then used is:

$$\bar{X} \pm t_{1(1/2)} = S/n^2$$

where  $\bar{X}$  is the sample mean,  $t$  is the  $t$  statistic,  $n$  is the number of samples, and  $S$  is the standard deviation. In the following example, assume that an investigator wishes to estimate the mean density of a species in a population within 10 percent of the actual number and with a 1-in-20 chance of being wrong. The  $t$  value is unknown and is a function of  $n-1$  degrees of freedom; however, for fairly large sample sizes,  $t$  is a weak function of  $n$  and is approximately 2.

(4) An additional factor which will limit the number of samples is financial resources. In this case, the number of samples upon which analyses can be performed is determined by the ratio of available dollars and cost per sample:

$$\text{Numbers of samples} = \frac{\text{Dollars available}}{\text{Cost per sample}}$$



29 May 87

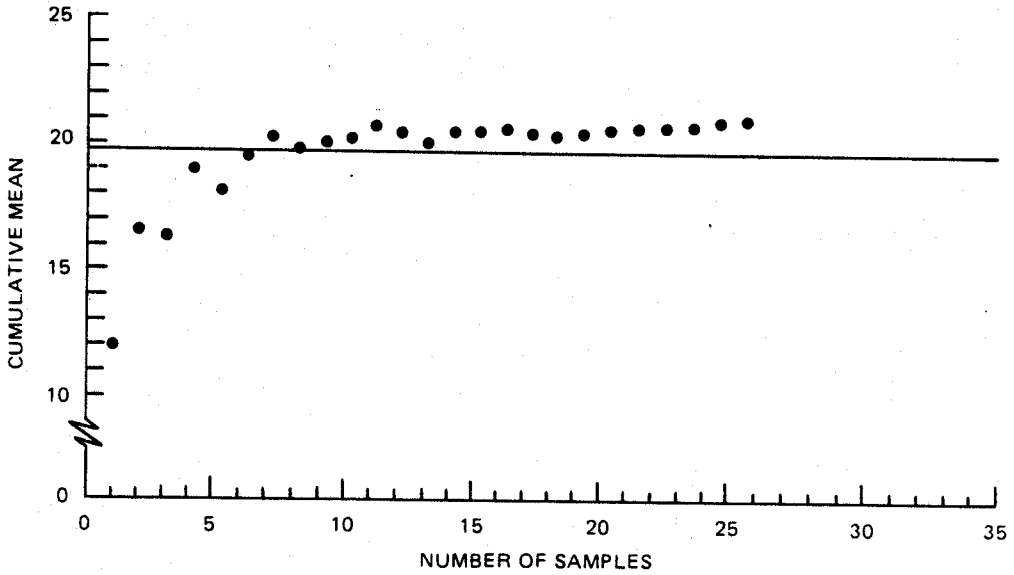

a. Random

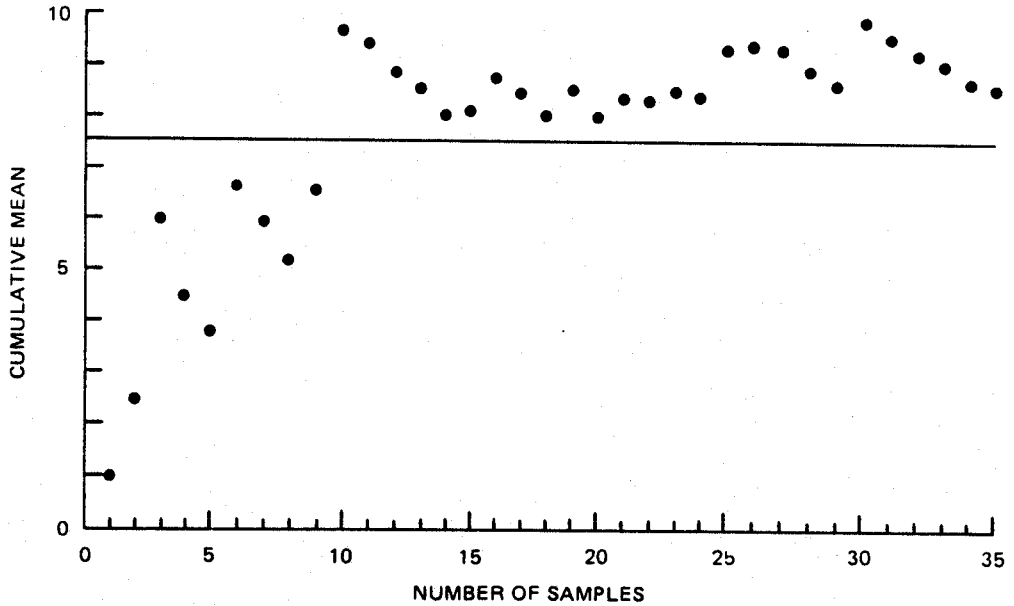

b. Cluster

Figure 5-4. Cumulative means calculated for random and cluster distributions

Table 5-1. Cumulative Means From a Series of Randomly Collected Samples Taken From a Population with Random Distribution

<u>Observation</u>	<u>No. of Individuals (X)</u>	<u>Sample Mean (X)</u>
1	12	12.0
2	21	16.5
3	16	16.3
4	27	19.0
5	15	18.2
6	27	19.6
7	25	20.4
8	15	19.8
9	25	20.3
10	21	20.4
11	25	20.8
12	19	20.6
13	15	20.2
14	25	20.6
15	22	20.6
16	23	20.8
17	19	20.7
18	20	20.6
19	24	20.8
20	23	20.9
21	23	21.0
22	21	21.0
23	22	21.1
24	27	21.3
25	22	21.4
Total	534	--
Standard deviation	4.16	--
Standard error of the mean	19.48	--

EM 1110-2-1202  
 29 May 87

Table 5-2. Cumulative Means From a Series of Randomly Collected Samples Taken From a Population with Cluster Distribution

<u>Observation</u>	<u>No. of Individuals (X)</u>	<u>Sample Mean (X)</u>
1	1	1.0
2	4	2.5
3	13	6.0
4	0	4.5
5	1	3.8
6	21	6.6
7	1	5.9
8	1	5.2
9	18	6.6
10	37	9.7
11	6	9.4
12	4	8.9
13	5	8.6
14	1	8.1
15	10	8.2
16	18	8.8
17	4	8.5
18	1	8.1
19	17	8.6
20	0	8.1
21	14	8.4
22	5	8.3
23	16	8.6
24	6	8.5
25	31	9.4
26	11	9.5
27	8	9.4
28	0	9.1
29	2	8.8
30	44	10.0
31	0	9.7
32	2	9.4
33	1	9.2
34	0	8.9
35	6	8.8
<b>Total</b>	<b>309</b>	<b>--</b>
<b>Standard deviation</b>	<b>10.9</b>	<b>--</b>
<b>Standard error of the mean</b>	<b>123.5</b>	<b>--</b>

This approach will provide one method of estimating the number of samples that can be collected and analyzed. However, should the calculated number of samples not be sufficient to establish an adequate sampling program (i.e., number of samples insufficient to allow triplicate sampling at all locations indicated in paragraph 5-3d), one of the following trade-offs will to be accepted:\*

(a) Reduce the replicate sampling at each station. This will allow the chemical distribution within the project area to be determined, but variability at a single sampling station location cannot be calculated.

(b) Maintain replicate sampling but reduce the number of sampling locations. This will result in the project area being less well defined, but sampling variability can be calculated.

(c) Increase the financial resources available for sample analysis. This will increase the number of samples that can be collected and analyzed.

(5) It is suggested that consideration be given to collecting samples (locations and numbers) in excess of that determined by the above process. Depending upon the parameters being evaluated, the samples do not have to be scheduled for analysis and may even be discarded later without analysis. Should sample analysis indicate some sort of abnormal results, it is easier to analyze additional samples already on hand rather than to remobilize a field crew. Also, the additional variable of different sampling times is avoided with this approach.

f. Frequency of Sampling. Frequency of sampling will depend on the available resources and the size of the project. In addition, seasonal fluctuations of sediment concentrations may be critical, or a single sampling prior to a dredging or filling operation may be sufficient for a new-work project. A sampling frequency of once per year would probably also be sufficient for an annual maintenance project, unless there is a reason to believe otherwise (i.e., some major change in point sources or basin hydrology).

g. Sampling Techniques Selection.

(1) Considerations. Sampling equipment should be selected based on reliability, efficiency, and contamination potential. Several types of sediment samplers are described in Table 5-3. Sediments are frequently stratified vertically as well as horizontally, and this source of variability should be considered when choosing a method of sampling (i.e., grab versus corer). A

---

\* The distinction between option (a) and option (b) should be based on project-specific goals. If option (a) is used (more stations, fewer replicates), the results will provide a better indication of distribution patterns in the project area (synoptic survey), but it will be difficult to compare individual stations. On the other hand, if option (b) is used (fewer stations, more replicates), the results will provide a better indication of variability at one location and comparison between sampling stations. However, the project area will be less well defined.

29 May 87

Table 5-3. Sediment Sampling Equipment

Sampler	Weight	Remarks
Peterson	39-93 lb	Samples 144-in. <sup>2</sup> area to a depth of up to 12 in., depending on sediment texture.
Shipek	150 lb	Samples 64-in. <sup>2</sup> area to a depth of approximately 4 in.
Ekman	9 lb	Suitable only for very soft sediments.
Ponar	45-60 lb	Samples 81-in. <sup>2</sup> area to a depth of less than 12 in. Ineffective in hard clay.
Drag bucket	Varies	Skims an irregular slice of sediment surface. Available in assorted sizes and shapes.
Phleger tube (gravity corer)	Variable: 17-77 lb; fixed in excess of 90 lb	Shallow core samples may be obtained by self-weight penetration and/or pushing from boat. Depth of penetration dependent on weight and sediment texture.
Reineck box sampler	1650 lb	Samples 91.3-in. <sup>2</sup> to a depth of 17.6 in.

29 May 87

grab sampler is a device that usually triggers after free-falling and is used to retrieve surficial sediments. The difficulty with this approach is that the depth of sediments penetrated by the sampler may vary, depending on the weight and shape of the sampler, the sediment texture and density, the height of free-fall, and the angle of impact.

(2) Maintenance projects. One situation where the selection between grabs and corers may not be critical is in the evaluation of dredging activities in maintenance work projects. In these areas, the sediments that have accumulated since the last maintenance project are generally subjected to continual reworking due to marine traffic. The net effect of this activity homogenizes the sediments that have accumulated. Because maintenance dredging is concerned with the removal of accumulated sediments rather than deepening or creating new channels, grab samplers should be sufficient in these situations.

(3) New work. When the project being evaluated includes either deepening of an older channel or creation of a new channel, it is recommended that cores be collected. Also, when possible, the cores should be taken to a depth equivalent to the proposed project depth.

h. Sample Preservation. The importance of sample preservation between time of collection and time of analysis cannot be overemphasized. The purpose of collecting samples is to gain an understanding of the source (point of origin) of the sample; any changes in sample composition can invalidate conclusions regarding the source of the samples. To phrase it another way, results based on deteriorated samples negate all efforts and costs expended to obtain good examples.

(1) The most efficient way to ensure a lack of sample deterioration is to analyze samples immediately. However, this is usually not practical and some method must be relied upon to extend the integrity of the sample until the analyses can be completed. In taking this approach, it must be remembered that complete stabilization is not possible and no single preservation technique is applicable to all parameters.

(2) Preservation is intended to retard biological action, hydrolysis, and/or oxidation of chemical constituents and reduce volatility of constituents. Refrigeration in an airtight container is the only acceptable method to preserve sediments for bioassays. The elapsed time between sample collection and sample preservation must be kept to an absolute minimum.

(3) The effects of transportation and preservation of sediment samples have not been fully evaluated. However, it is suggested that sediment samples be sealed in airtight glass containers to preserve the anaerobic integrity of the sample and maintain the solid phase-liquid phase equilibrium.

#### 5-4. Data Analysis, Interpretation, and Presentation of Results.

a. Data Analysis Plan. A plan for data analysis should be formulated at the experimental design step since the type of analysis selected will dictate the number and frequency of samples or measurements which must be taken. Several techniques are available for data analysis.

(1) Qualitative analysis. Results of qualitative analyses are generally prose statements based on visual observations, inductive reasoning, and perhaps a few measurements: for example, "Disposal of dredged material from site 2 off Brown's Point has caused local increases in turbidity. A turbidity plume has been observed extending approximately 600 feet to the southwest during three different disposal operations." The value of qualitative analysis can be substantial if it can be established that other factors which could affect results were controlled, constant, or not applicable. The following addition to the previous statement considerably enhances its usefulness. "No turbidity plumes have been observed in this area during other disposal operations. Investigation of other factors that could have caused a turbidity plume of this size has ruled out all other reasonable explanations for its existence."

(2) Maps and graphical analysis. Patterns inherent in data can often be revealed by mapping or graphing the data. Maps are used to show two- and three-dimensional spatial patterns, whereas graphical approaches are most useful for showing temporal relationships or variations with a single dimension such as distance or depth. In general, variables can be divided into two types--continuous and discontinuous (or discrete)--and appropriate map and graphical techniques vary, depending on how variables are measured and distributed.

(a) Maps. Phenomena to be mapped may be distributed in a continuous or discrete manner. Discrete distributions are composed of individual elements that are countable or measurable (such as people, fish, or trees), whereas with continuous distributions there are no recognizable individuals (e.g., air temperature or rainfall). Symbols such as dots may be used to map discrete distributions to reveal patterns. Discrete data are often converted into densities by dividing counts of individuals (frequencies) by the areas of the spatial observation units. The results (people per square mile, biomass per square feet, etc.) may be plotted on maps. Patterns are often enhanced by grouping all values into five or six classes and mapping each class with a separate tone or color. Data representing continuous distribution are usually plotted and contoured to reveal patterns (Figure 5-5).

(b) Graphs. Graphic techniques specialized for certain disciplines or types of data are too numerous to describe. As with maps, however, graphic techniques vary with the type of data. Discrete data are often graphed as frequency histograms (or by graphs), with frequencies on the vertical axis and classes or categories on the horizontal axis. Continuous data are usually plotted as curves, with the spatial or temporal dimension on the X-axis and the values of the variables on the Y-axis. Logarithmic scales are often used when the data to be graphed vary over more than one order of magnitude. Patterns or trends in irregular curves may be more evident if the data are smoothed with a moving average or by fitting generalized mathematical functions to the plotted points. (Schmid and Schmid (1979) provides a thorough review of graphs and charts; Tukey (1977) provides a discussion of graphical smoothing techniques.)

(c) Complex graphics. More complex maps and graphs such as three-dimensional contour plots, trend surfaces, and perspective plots are also useful, but more difficult to comprehend. Various map and geographical options are available as part of most data management systems.

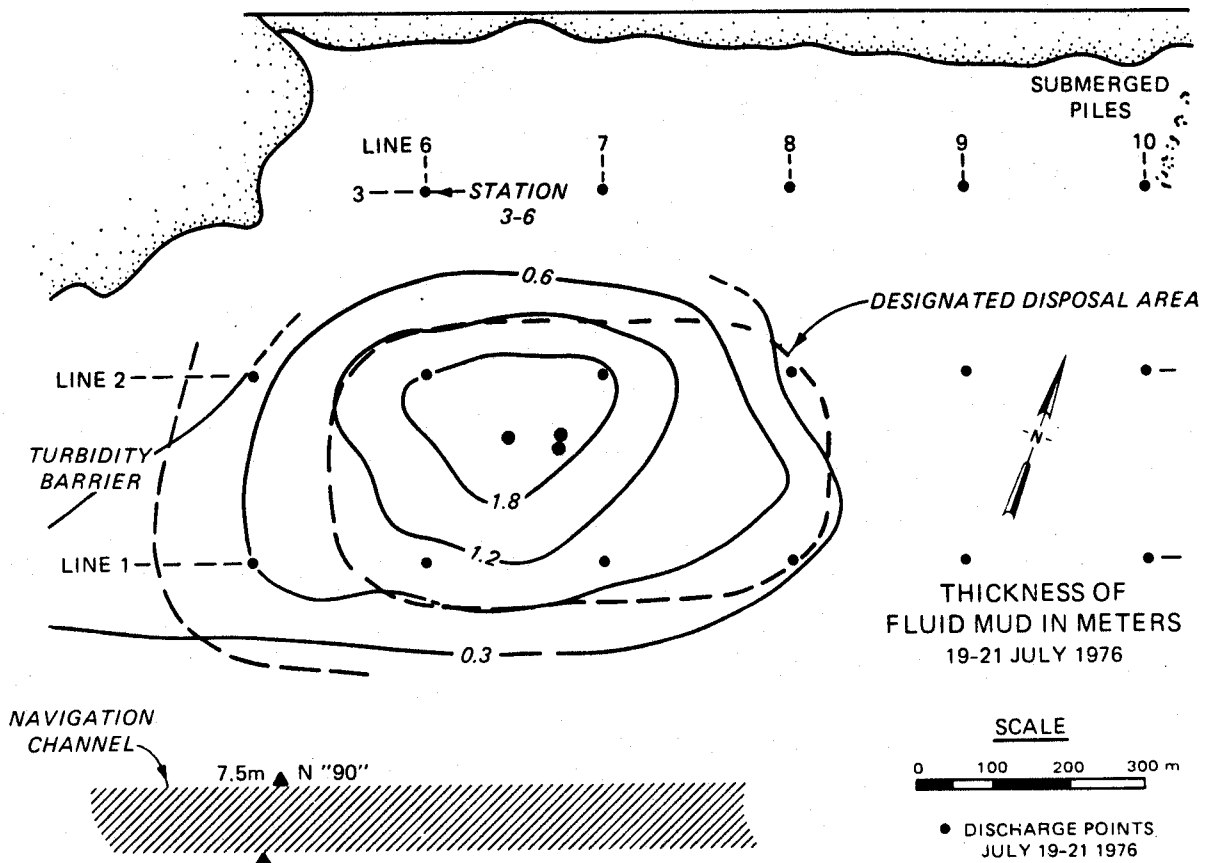

Figure 5-5. Example of continuous distribution displayed by contour map. Contours depict horizontal distribution of fluid mud thickness during open-water dredged material disposal (compiled from acoustic measurements)

(d) Common errors. When using maps and graphic techniques, one must be careful not to draw conclusions that implicitly depend on interpolation between data points (Figure 5-6) or extrapolation beyond the range of the data (Figure 5-7), unless such interpolation or extrapolation can be justified. A choice of scales or coordinate axes that unduly exaggerate or minimize point scatter or differences should be avoided.

(3) Statistical analysis. Statistical analysis can be used to summarize or describe complex data bases. Statistics can also be used as a formal decisionmaking tool to decide whether measured temporal or spatial differences between samples are real or whether they may be the result of sampling variability. Commercially available data management systems (paragraph 5-5) have options for computing and displaying several types of statistics.

(a) Descriptive statistics. Large amounts of data can be summarized by calculating statistics such as measures of central tendency (mean, median, and mode) and dispersion (standard deviation and range). Statistics can be used to compare sets of data to determine if differences exist among them and, if so, whether the differences are meaningful.



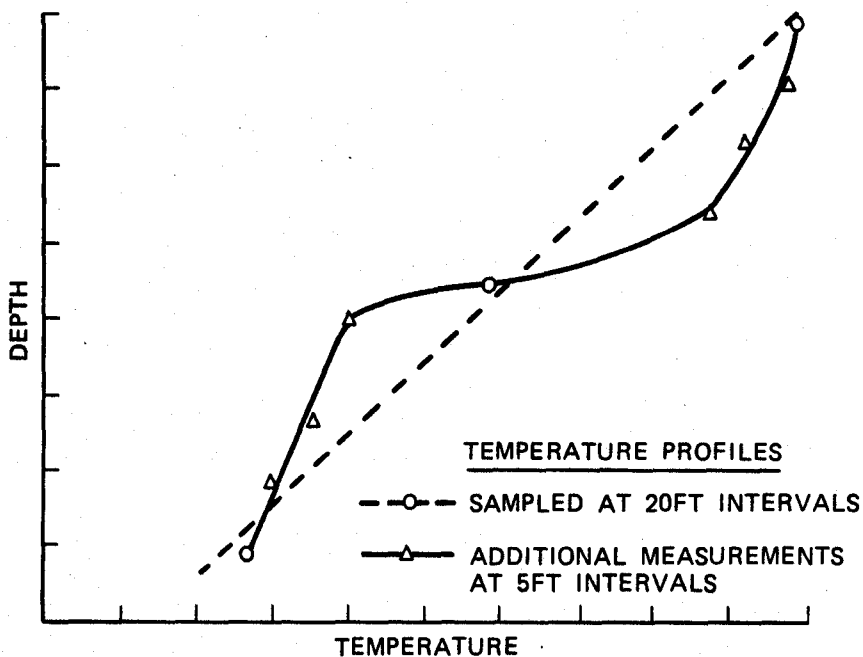

Figure 5-6. Error caused by improper interpolation. Depth-temperature relationship appears linear when sampled at 20-foot intervals, but nonlinear when sampled at 5-foot intervals

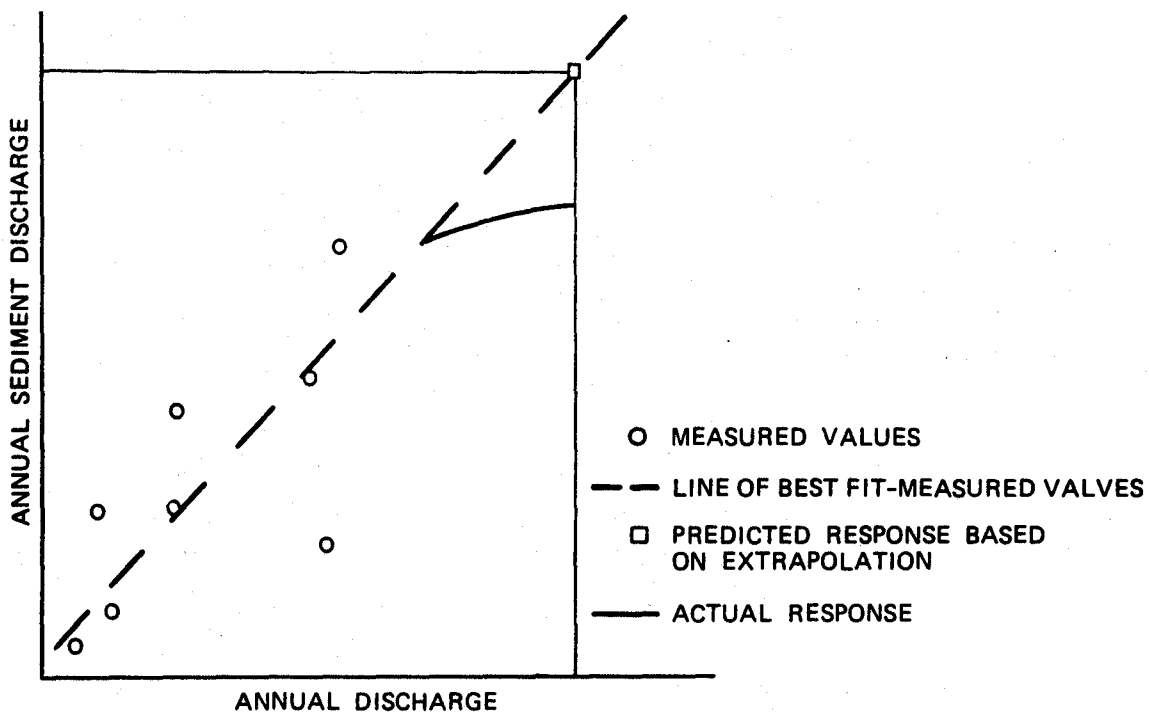

Figure 5-7. Error caused by improper extrapolation

(b) Hypothesis testing. Formulas are available for determining if observed differences between sample data sets are real, or if they may have occurred by chance due to the size or selection of samples used in calculating the statistics. These techniques are called significance tests, and theories and formulas for their use are given in basic texts on statistics and experimental design. Users should be cautioned, however, that observed differences may be statistically significant and yet not be very meaningful. Special techniques have been developed for analysis of biological data, particularly benthic biota data. (Pequegnat et al. (1981) and Sokal and Rohlf (1960) review several of these techniques.)

(c) Correlation and regression. Relationships among variables may be explored using correlation and regression analysis. For example, the relationship between the density of a certain benthic species and certain physical (velocity, temperature, sediment grain size) and chemical (DO) parameters might be explored using correlation and regression. Basic theory and formulas for correlation and regression are given in statistics texts. It is important to understand that high correlations do not imply cause-and-effect relationships. Kenney (1982) discusses spurious self-correlations which result when another variable that is a ratio, product, sum, or difference is correlated with another variable that has a common term. Correlation and regression with several variables should not be attempted without a good understanding of the basic assumptions that must be met in order to use the techniques effectively. Misuse of regression and correlation is discussed in most multivariate statistical texts. Mather (1976) presents a thorough discussion of the basic assumptions of multiple correlation and regression and of some of the mathematical and data constraints that influence results.

(d) Advanced statistical techniques. Most data management systems contain programs for a variety of advanced statistical techniques which may be useful for describing patterns and explaining complex relationships among many variables. Use of these analytical techniques should generally be avoided except by individuals with sufficient training to understand the statistical and mathematical constraints to proper use of the techniques.

#### b. Data Interpretation.

(1) Editing. Database checking and editing should precede analysis. Extreme errors may be detected by computer programs that check for boundary conditions and ensure data values are within reasonable limits. Quality work requires human judgment. Simple computer-generated plots of the raw data should be generated and examined for unreasonable values, extreme values, trends, and outlines. More detailed editing should include checking all or random samples of the computer database values against data sheets from the lab or field.

(2) Analysis. The next step in data interpretation is to ensure that the assumptions on which the data analysis plan is based are still valid. New information or failure to collect all the data required by the original analysis plan may necessitate modification. Data analysis should then proceed according to plan, and a decision should be made to accept or reject the hypothesis. Following this step, an effort should be made to identify additional quantitative or qualitative conclusions that may be warranted, and additional

29 May 87

hypotheses that may be tested using the database. If resources permit, this additional analysis may be completed prior to formulation of final conclusions. Final conclusions should not be limited to acceptance or rejection of hypotheses, but should extend to clear, verbal expression of the implications of the observed results. Decisionmakers who are not technical specialists may fail to grasp these implications unless they are clearly communicated.

c. Presentation of Results. Results should be presented in a format appropriate for the majority of the intended audience. Presentation of large volumes of numerical data is generally undesirable; however, provision should be made for long-term data storage and retrieval. Graphical displays can be effective if the complexity of the plots is not too great for the selected audience. A few representative, simplified plots which serve as examples of major findings or conclusions are generally best.

#### 5-5. Database Management.

a. General. The success of any study effort, especially one involving multiple investigators and disciplines, will be heavily influenced by the quality of plans to deal with: (1) data management, storage, and retrieval of information, and (2) the compatibility between data units and formats and programs for data reduction and analysis. A carefully designed plan for handling information will guarantee that once field and laboratory work is completed, information will be readily available for examination and analysis and in a form useful to management.

b. Data Management Plan. A data management plan detailing procedures for handling data storage and retrieval should be formulated at the outset of an environmental study. The simplest type of database contains only data developed for a single study. A more cost-efficient approach is to develop a single database for all environmental studies within the Corps field office with standardization of measurement and reporting procedures to ensure internal compatibility. Once the database is developed, the database manager should be conservative in decisions about changes in procedures or data units and should permit such changes only where useful information benefits can clearly be identified.

c. Database Incompatibility. Frequently, various studies associated with one project will be conducted by several different agencies or contractors. It is also not unusual that during the course of a project, the same scope of work might be performed by different contractors at different times. Besides reinforcing the need for standardization discussed above, the probability of a multiple-contractor operation stimulates logistical questions about information storage, retrieval, and analysis. The Federal agencies, academic institutions, and consulting companies who ordinarily conduct the work will usually have their own computer support. This situation could lead to the formation of several different data files existing in different computers.

29 May 87

Database incompatibilities will create problems for those who have responsibility for synthesizing the products of multiple investigators. Also, a new contractor performing a scope of work previously performed by a different contractor will encounter problems when attempting comparative analyses involving the two sets of observations. Two solutions to this problem are possible.

(1) Central computer. This solution would require all contractors to use the same computer; the field office would also need access to data files stored in this computer. This solution is not recommended however because it deprives the contractor of computer services and programs he is most familiar with and, therefore, could use most efficiently.

(2) Individual computers. This solution, which is the recommended approach, would permit each contractor the computer of his choice. However, each contractor must be required to transmit information to the Corps field office in a machine-readable form compatible with the Corps' computer and in standardized format and units. As noted above, any changes in format, units, or approach should be carefully considered because those changes would have system-wide impacts.

5-6. Water Quality and Biological Data Collection Considerations. This paragraph outlines the considerations involved in data collection on the aquatic and biological aspects of deep-draft navigation projects.

a. Water Quality.

(1) Regulations. Section 103 of MPRSA specifies that all proposed operations involving the transportation and dumping of dredged material into ocean waters be evaluated to determine the potential environmental impact of such activities. This must be done by the Secretary of the Army and the Administrator of the EPA acting cooperatively through the District Engineer and Regional Administrator. Environmental evaluations must be in accordance with criteria published by EPA (40 CFR 220). Section 404(b) of the Clean Water Act (CWA) specifies that any proposed discharge of dredged or fill material into navigable waters must be evaluated through the use of EPA guidelines developed jointly with the Secretary of the Army. The District Engineer must make the evaluation in accordance with guidelines published by EPA (40 CFR 230).

(2) Environmental consequences.

(a) Ecological impacts. Ecological impacts of the discharge of dredged or fill material can be divided into two main categories: physical effects and chemical-biological interactive effects. Physical effects are often straightforward, and evaluation may often be made (without laboratory tests) by examining the character of the dredged or fill material proposed for discharge and the sediments of the discharge area with particular emphasis on the principles delineated in EPA regulations. However, the chemical-biological interactive effects resulting from the discharge of dredged or fill material are usually difficult to predict.

(b) Approach. Often there are concerns over the potential environmental consequences of discharge operations. The principal concern regarding open-water discharge of dredged or fill material that contains chemical

29 May 87

contaminants relates to the potential effects on the water column and benthic communities due to the presence of the contaminants. These concerns can be addressed by the following approaches:

1 Release of chemical contaminants from the sediment to the water column may be simulated by use of an elutriate test.

2 To the extent permitted by the state of the art, expected effects such as toxicity, simulation, inhibition, or bioaccumulation may be estimated by appropriate bioassays and biological assessments.

3 An evaluation or comparison of proposed disposal sites and an inventory of sediment and water constituents may be evaluated by the use, where appropriate, of total sediment analysis or bioevaluation. Considering the potential complexity of involved ecosystems, no single test can be used to evaluate all effects of proposed discharges of dredged or fill material. Consequently, the guidelines and criteria published by EPA provide a general protocol to be used in the technical evaluation of the proposed activities. Each procedure used should provide relevant information about the proposed discharge activity. There are, however, limitations associated with the use of the results obtained with each procedure, and no one procedure should arbitrarily be relied upon to the exclusion of the others. For example, total sediment analysis results cannot be used to assess water quality effects, and elutriate test results cannot be used to assess effects on benthic organisms. Also, when it becomes necessary to perform bioassays as part of the evaluation procedure, experimental conditions should reflect the exposure times and exposure concentrations that would be expected in the field based on the dilution and dispersion at the proposed disposal site. Each of these limitations must be considered when selecting, conducting, and evaluating the results of the procedures required by EPA regulations.

### (3) Procedural guidance.

(a) General. The EPA, in conjunction with the Corps of Engineers, has published a comprehensive procedures manual (US Environmental Protection Agency/US Army Corps of Engineers Technical Committee on Criteria for Dredged and Fill Material 1977) that contains summaries and descriptions of tests, definitions, sample collection and preservation procedures, analytical procedures, calculations, and references required for detailed water quality evaluations in accordance with EPA requirements. The purpose of this manual is to provide a state-of-the-art summary on sampling, preservation, and analysis of water and dredged and fill material. The information compiled and presented in this manual consists of three major sections:

1 A discussion of rationale for project or study managers.

2 A step-by-step protocol for sample collection and handling and each test procedure.

3 A listing of analytical techniques, including sample pretreatment procedures.

It is expected that this manual will receive wide use as an aid in the regulatory process.

(b) CWA, Section 404(b). Interim guidance for implementing Section 404(b) of the CWA was published in 1976 (US Army Engineer Waterways Experiment Station 1976). It should be viewed as a second generation in the continuing process of procedure development, refinement, and evaluation of the CWA requirements. Thus, the interim guidance is intermediate between the EPA regulations and analytical compendiums such as Standard Methods for the Examination of Water and Wastewater including bottom sediments and sludges (American Public Health Association 1975), the American Society of Testing and Materials (ASTM) manual (American Society for Testing and Materials 1976), and the EPA manual (US Environmental Protection Agency 1979).

(c) MPRSA, Section 103. The primary intent of Section 103 of the MPRSA (US House of Representatives, Committee on Public Works 1973) is to regulate and limit the adverse ecological effects of ocean dumping. Consequently, the EPA-implementing regulation emphasizes evaluative techniques such as bioassays and bioassessments, which provide direct estimations of the potential for environmental impact. To properly conduct the required evaluation requires considerable expertise in conducting biological evaluations. In addition, significant continuing effort and expense are entailed in collecting and culturing sufficient stocks of all the necessary species of organisms and maintaining them in good condition in the laboratory to use whenever an evaluation must be conducted. Consequently, an ocean dumping manual has been published jointly by the EPA and the Corps pursuant to the Ocean Dumping Act (US Environmental Protection Agency/US Army Corps of Engineers Technical Committee on Criteria for Dredged and Fill Material 1977). The ocean dumping manual represents a multidisciplinary effort of both agencies to develop procedurally sound, routinely implementable guidance for complying with the technical requirements of EPA regulations. The procedures given in the manual are applicable to evaluation of the potential ecological effects of dumping from hopper dredges, barges, and scows. The EPA requirements are discussed, and detailed guidance is provided on sediment and water sample collection, preparation, and preservation; chemical analysis of the liquid phase; bioassays of liquid, suspended particulate, and solid phases; estimation of bioaccumulation potential; and estimation of initial mixing. Even though the manual was developed for the ocean dumping program, the approaches have broad application to all aquatic systems for water quality evaluation. A companion quality assurance and quality control manual (Lang et al. 1981) has been developed to aid agencies in giving clear and concise guidance to contractors conducting ecological evaluations. These manuals, used in conjunction with those identified in the previous paragraph, provide a powerful set of tools for use in water quality evaluations.

(d) Data collection and analyses. The collection and preparation of water and dredged material samples for testing and evaluation are the most important factors leading to an evaluation of the impact of dredging and dredged material discharge upon the aquatic environment. Samples that are improperly collected, preserved, or prepared will invalidate any testing results and lead to erroneous conclusions regarding the potential impact of the proposed discharge. Attention must therefore be given to all phases of water and sediment sampling, storage, preparation, and analysis. The procedures described in the referenced manuals specify the apparatus and procedures to use

29 May 87

for sampling water and dredged material and for preparing the water and dredged material for chemical analyses and bioassay procedures.

b. Altered Circulation Due to Changes in Geometry. Water quality effects may sometimes be inferred from effects on hydrodynamics and salinity, as outlined in paragraph 3-1. The necessity and design of water quality sampling for the application of numerical modeling are highly dependent upon the selected methodology, as discussed in Appendix C. Methods of sample collection, preservation, and analyses published by the American Public Health Association (1975) and EPA (USEPA 1979) should be used.

c. Biological Data.

(1) Evaluative techniques such as bioassays and bioassessments provide direct estimations of the potential for environmental impact due to contaminated sediments. However, as discussed, such evaluations require considerable expertise and significant continuing effort and expense; for these reasons, obtaining the services of different groups to conduct each evaluation would be impractical. Thus, it is highly recommended that a few groups that have demonstrated bioassay capability be selected, with each group conducting evaluations for a number of permit applications. This will enable these groups to develop adequate culturing and maintenance capabilities and the expertise and familiarity with the procedures required to implement them properly and provide the most reliable results at the least cost per evaluation.

(2) It should be recognized that dredged material bioassays cannot be considered precise predictors of environmental effects. They must be regarded as quantitative estimators of those effects, making interpretation somewhat subjective. In order to avoid adding more uncertainty to their interpretation, most dredged material bioassays use mortality as an end point. The significance of this response to the individuals involved is clear; it remains impossible to predict the ecological consequences of the death of a given percent of the local population of a particular species. For example, there is presently no basis for estimating whether the loss at the disposal site of 10 percent of a particular crustacean species would have inconsequential or major ecological effects.

(3) The suspended particulate phase of dredged material may be evaluated for potential environmental impact only by use of bioassays. No chemical procedure has yet been devised that will determine the amount of environmentally active contaminants present in the suspended particulate phase of dredged material. Therefore, bioassays are used to evaluate directly the potential for biological impacts due to both the physical presence of suspended particles and to any biologically active contaminants associated with the particulates and/or the dissolved fraction.

(4) It is generally accepted that the greatest potential for environmental impact from a given dredged material lies in the solid phase. This is because it is not mixed and dispersed as rapidly or as greatly as suspended phases. No chemical procedures exist that will determine the environmental activity of any contaminants or combination of contaminants present in the solid phase of dredged material. Therefore, animals are used in a bioassay to

29 May 87

provide a measurement of environmental activity of the chemicals found in the material.

(5) Biological evaluations of dredged material often include an assessment of the potential for contaminants from the dredged material to be bioaccumulated in the tissues of organisms. This is intended to assess the potential for the long-term accumulation of toxins in the food web to levels that might be harmful to the ultimate consumer, which is often man, without killing the intermediate organisms. In order to use bioaccumulation data, it is necessary to predict whether there will be a cause-and-effect relationship between the animals' presence in the dredged material and a meaningful elevation of body burdens of contaminants above those of similar animals not in the dredged material.

(6) Since concern about bioaccumulation is focused on the possibility of gradual uptake over long exposure times, primary attention is usually given to the solid phase that is deposited on the bottom. A variety of laboratory research methods for measuring bioaccumulation are presently undergoing modification and evaluation as regulatory tools. All such methods require one month or more for completion and provide no quantitative method for considering field conditions, such as mixing, in the interpretation of the results. Field sampling programs overcome the latter difficulty since the animals are exposed to the conditions of mixing and sediment transport actually occurring at the disposal site in question. The former difficulty is also overcome if organisms already living at the disposal site are used in the bioaccumulation studies. The use of this approach for predictive purposes is technically valid only where there exists a true historical precedent for the proposed operation being evaluated. That is, it can be used only in the case of maintenance dredging where the quality of the sediment to be dredged is considered not to have deteriorated or become more contaminated since the last dredging and disposal operation. In addition, the disposal must be proposed for the site at which the dredged material in question has been previously disposed or for a site of similar sediment type supporting a similar biological community.

(7) Considering these limiting conditions, it is possible to assess bioaccumulation by animals that have spent major portions of their life in or on a sediment very similar to the sediment in question, under the physical and chemical conditions actually occurring at the disposal site. Caged animals of suitable species may also be placed at appropriate stations in and around the disposal site, but this will require a substantial exposure time before analysis.

(8) Under the above conditions, a field assessment provides the most useful information because the animals have been exposed to the sediment under natural conditions for longer periods than are now generally practical in the laboratory. To the extent that source control has prevented increased input of contaminants, it will generally be true that sediment quality at dredging sites will not be lower than at the time of previous dredging and disposal operations. Therefore, since the same disposal site is traditionally used repeatedly for each dredging site, a valid historical precedent probably exists for most disposal operations.



29 May 87

(9) The environmental interpretation of bioaccumulation data is even more difficult than for bioassays because in most cases it is impossible to quantify either the ecological consequences of a given tissue concentration of a constituent that is bioaccumulated or the consequences of that body burden to the animal whose tissues contain it. Almost without exception in the aquatic environment, there is no technical basis for establishing, for example, the tissue concentration of zinc in a species of crustacean that would be detrimental to that organism, not to mention the impossibility of estimating the effect of that organism's body burden on a predator. Therefore, in order to ensure environmental safety, interpretative guidance often assumes that any statistically significant bioaccumulation relative to animals not in dredged material, but living in material of similar sedimentological character, is potentially undesirable. The evaluation of experimental results using this approach requires the user to recognize the fact that a statistically significant difference cannot be presumed to predict the occurrence of an ecologically important impact.

(10) In bioassays, marine organisms are used, in a sense, as analytical instruments for determining the environmentally active portions of any contaminants present. Lack of effect in bioassays and bioaccumulation studies is taken to mean that contaminants are absent or present only in amounts and/or forms that are not environmentally active. When effects do occur in dredged material bioassays, it is not possible within the present state of knowledge to determine which constituent(s) caused the observed effects. Indeed, if an adverse effect occurs, it matters little from a regulatory viewpoint whether that effect is due to the physical presence of the sediment or is due to some chemical constituent(s) associated with the sediment carried beyond the site. Therefore, it is important to realize that this benthic bioassay measures the total impact of the dredged material--that impact may be due to an unrecognized pollutant or to the synergistic effects of many pollutants, none of which may have an exceptionally elevated concentration. At the present technical state of the art, it is not possible to determine by any known chemical analysis which pollutant(s) may be the causative agent(s).

CHAPTER 6

MITIGATION DECISION ANALYSIS

6-1. Policy. Care must be taken to preserve and protect environmental resources, including unique and important ecological, aesthetic, and cultural values. Specific mitigation policy for significant fish and wildlife and historic and archeological resources is included in ER 1105-2-50, Chapters 2 and 3. Damage from Federal navigation work along the shorelines of the United States must be prevented or mitigated (ER 1105-2-20, 2-1.d; ER 1105-2-10, E-7).

6-2. Definition.

a. Mitigation. The Council on Environmental Quality (CEQ), in its Regulations for Implementing the Procedural Provisions of the National Environmental Policy Act (40 CFR Part 1508.20), published a definition of mitigation that has been adopted by the Corps (ER 1105-2-50) and includes: avoiding the impact altogether by not taking a certain action or parts of an action; minimizing impacts by limiting the degree of magnitude of the action and its implementation; rectifying the impact by repairing, rehabilitating, or restoring the affected environment; reducing or eliminating the impact over time by presentation and maintenance operations during the life of the action; or compensating for the impact by replacing or providing substitute resources or environment.

b. Significant Resources and Effects. The criteria for determining the significance of resources and effects that are provided in the Principles and Guidelines (P&G) Section 1.7.3 (ER 1105-2-30, Appendix A) and Subsections 3.4.3 and 3.4.12 (ER 1105-2-50, Appendix A), and 40 CFR Part 1508.27 will be adopted for this manual.

6-3. Justification for Mitigation.

a. Justification of mitigation measures must be based on the significance of the resource losses due to a project, compared with the costs necessary to carry out the mitigation (ER 1105-2-10, 2-4c.1) The extent of justified mitigation will be determined through coordination with the US Fish and Wildlife Service and any other concerned agency or government. Endangered and threatened species and critical habitats will be given special consideration, with specific requirements for these resources covered in the Endangered Species Act of 1973, (ER 1105-2-50, 2-5g).

b. Impacts resulting from dredged material disposal and hydraulic changes are largely on bay bottoms, shorelines, wetlands, vegetated shallows, and riparian zones. These areas will usually be composed of our considered to be significant resources. Appendix C of ER 1105-2-50 (Subparts C-F) describes potential impacts on these resources.

6-4. Key Concepts for Mitigation.

a. Early Participation. To determine significant resource losses that will occur because of a project, environmental personnel must be involved in the project from the beginning. Once such potential losses are identified, the project can be modified to reduce or eliminate them. If modification is inadequate or infeasible, measures to offset the losses should be considered.

b. Long-Term Planning. Hershman and Ruotsals (1978) suggest building mitigation into a long-term estuary management plan, such that development and environmental protection proceed simultaneously. This approach allows cumulative impacts to be mitigated, decreases time and cost per project, and spreads the mitigation burden more equitably.

c. Habitat-Based Evaluation. The perspective of the Corps' environmental policy (ER 1105-2-50) is based on ecosystem structure and function. A habitat-based approach to quantifying resources is therefore in order, as opposed to methods relying on population data or use-days. Mitigation of habitat losses normally maintains ecosystem structure and function.

d. Mitigation Planning Goals. The options for mitigation efforts are (1) in-kind: resources physically, biologically, and functionally similar to those being altered; (2) out-of-kind: resources as above, dissimilar; (3) on-site: occurring on, adjacent to, or in the immediate proximity of the project site; and (4) off-site: occurring at a point away from the project site. (Option (4) is least acceptable to the Corps). The US Fish and Wildlife Service has prepared a guide selecting combinations of these options for mitigation (US Fish and Wildlife Service 1980). This reference also outlines resource categories and attendant mitigation goals and suggests measures for mitigation, tied to the definition of mitigation.

CHAPTER 7

CHECKLIST OF STUDIES

7-1. The following checklist identifies some of the environmental factors that should be considered for deep-draft navigation projects. This checklist is cumulative, and not all studies are appropriate for all projects.

- a. Characterization of existing conditions at project site, including habitat and other environmental characteristics.
- b. Estimation of construction activities by others likely to be associated with Federal projects.
- c. Evaluation of project effects on circulation patterns and salinity distribution.
- d. Evaluation of project effects on water quality.
- e. Characterization and testing of sediments to be dredged (Section 404 or 103 evaluation as appropriate).
- f. Analysis of dredging alternatives (dredge plant, timing, etc.).
- g. Analysis of disposal alternatives.
- h. Evaluation of project effects on sedimentation rates and shoaling locations.
- i. Analysis of effects of winter navigation if ice coverage will occur.
- j. Evaluation of aesthetic, cultural, and recreational aspects.
- k. Coordination with other agencies, the public, and private groups.
- l. Planning and design of monitoring programs.

APPENDIX A

BIBLIOGRAPHY

1. American Public Health Association. 1975. Standard Methods for the Examination of Water and Waste Water Including Bottom Sediments and Sludges, 14th Edition, APHA, New York, New York, 1193 pp.
2. American Society for Testing and Materials. 1976. "Part 31, Water." ASTM, Philadelphia, Pa.
3. Ariathurai, Ranjan. 1982 (Jul). "Two and Three Dimensional Models for Sediment Transport," Resource Management Associates, Lafayette, Calif.
4. Butler, H. L. 1979. "Evaluation of a Numerical Model for Simulating Long Period Wave Behavior in Ocean-Estuarine Systems," Estuarine and Wetland Processes, P. Hamilton and K. B. MacDonald, eds., Plenum Press, New York.
5. Coastal Zone Management Journal. 1982. Vol 9, No. 3/4, Crane, Russak and Company, Inc., New York.
6. Dyer, K. R. 1979. Estuarine Hydrography and Sedimentation, Cambridge University Press, Boston.
7. Edinger, J. E., and Buchak, E. M. 1981. "Estuarine Laterally Averaged Numerical Dynamics," Miscellaneous Paper EL-81-9, US Army Engineer Waterways Experiment Station, Vicksburg, Miss.
8. Elliott, J. M. 1977. "Some Methods for the Statistical Analysis of Samples of Benthic Invertebrates," Scientific Publication No. 25, Freshwater Biological Association, Ferry House, U.K.
9. Green, R. H. 1979. Sampling Design and Statistical Methods for Environmental Biologists, John Wiley & Sons, New York.
10. Herner and Company. 1980 (Apr). "Synthesis of Research Results, Dredged Material Research Program," Technical Report DS-78-23, US Army Engineer Waterways Experiment Station, Vicksburg, Miss.
11. Hershman, M. J., and Ruotsala, A. A. 1978 (Mar). "Implementing Environmental Mitigation Policies," Coastal Zone '78, San Francisco, Calif., Vol II, pp 1333-1345, American Society of Civil Engineers, New York, N.Y.
12. Hudson, R. Y., et al. 1979. "Coastal Hydraulic Models," Special Report No. 5, US Coastal Engineering Research Center, Fort Belvoir, Va.
13. Hurst, C. K., and Brenner, A. 1969. "Shore Erosion and Protection, St. Lawrence River - Canada," Permanent International Association of Navigation Congresses, Twenty-Second International Congress.
14. Hynson, J. R., et al. 1983. "Environmental Features for Levee Projects," US Army Engineer Waterways Experiment Station, Vicksburg, Miss.

15. Johnson, B. H. 1980. "VAHM - A Vertically Averaged Hydrodynamic Model Using Boundary-Fitted Coordinates," Miscellaneous Paper HL-80-3, US Army Engineer Waterways Experiment Station, Vicksburg, Miss.
16. Kendall, D. R. 1983. "The Role of Physical-Chemical Factors in Structuring Subtidal Marine and Estuarine Benthos," Technical Report EL-83-2, US Army Engineer Waterways Experiment Station, Vicksburg, Miss.
17. Kenney, B. C. 1982. "Beware of Spurious Self-Correlations!" Water Resources Research, Vol 18, No. 4, pp 1041-1048.
18. King, Ian P. 1982 (Jul). "A Finite Element Model for Three-Dimensional Flow," Resource Management Associates, Lafayette, Calif.
19. King, I. P., and Norton, W. R. 1978 (Jul). "Recent Application of RMA's Finite Element Models for Two-Dimensional Hydrodynamics and Water Quality," Finite Elements in Water Resources, Proceedings of the Second International Conference on Finite Elements in Water Resources, Pentech Press.
20. Lang, P., et al. 1981. "Guidance for Contracting Biological and Chemical Evaluations of Dredged Material," prepared by the US Army Engineer Waterways Experiment Station, Vicksburg, Miss., for the US Army Engineer District, New York.
21. Leendertse, J. J. 1967 (May). "Aspects of a Computational Model for Long-Period Water-Wave Propagation," RM-5294-PR, The Rand Corporation, Santa Monica, Calif.
22. Leendertse, J. J., et al. 1973. "A Three Dimensional Model for Estuaries and Coastal Seas; Vol 1, Principles of Computation," R-1417-OWWR, Rand Corporation, Santa Monica, Calif.
23. Lunz, J. D., Clarke, D. G., and Fredette, T. J. 1984a. "Seasonal Restrictions on Bucket Dredging Operations, A Critical Analysis with Recommendations," Proceedings of Dredging '84 ASCE Specialty Conference on Dredging and Dredged Material Disposal, Clearwater Beach, Florida.
24. Lunz, J. D., Clarke, D. G., and Fredette, T. J. 1984b. "Seasonal Restrictions on Dredging Operations," A Preliminary Critical Review of the Arguments for Seasonal Restrictions with Suggested Criteria and a Method to Determine the Need for Seasonal Restrictions on Federal and Permit Dredging Projects. Prepared for US Army Engineer District, New York.
25. Mann, R., et al. 1975. "Landscape Concept Development for Confined Dredged Material Sites," Contract Report D-75-5, US Army Engineer Waterways Experiment Station, Vicksburg, Miss.
26. Mather, P. M. 1976. Computational Methods for Multivariate Analysis in Physical Geography, John Wiley & Sons, New York.

27. McAnally, William H., et al. 1984. "Columbia River Estuary Hybrid Model Studies, Verification of Hybrid Modeling of the Columbia River Mouth," Report No. 1, US Army Engineer Waterways Experiment Station, Vicksburg, Miss.
28. Mulvihill, E. L., Francisco, C. A., Glad, J. B., Kaster, K. B., and Wilson, R. E. 1980. "Biological Impacts of Minor Shoreline Structures on the Coastal Environment: State of the Art Review," National Coastal Ecosystems Team, Washington, D. C.
29. Norton, W. R., et al. 1973. "A Finite Elements Model for Lower Granite Reservoir," prepared for US Army Engineer District, Walla Walla, Wash.
30. Nunnally, N. R., and Shields, F. D. 1983. "Procedures for Incorporating Environmental Features in Design and Construction of Flood Control Channel Projects," Technical Report E-85-3, US Army Engineer Waterways Experiment Station, Vicksburg, Miss.
31. Pequegnat, W. E., Pequegnat, L. H., James, B. M., Kennedy, E. A., Fay, R. R., and Fredericks, A. D. 1981. "Procedural Guide for Designation Surveys of Ocean Dredged Material Disposal Sites," Technical Report EL-81-1, US Army Engineer Waterways Experiment Station, Vicksburg, Miss.
32. Schmid, C. F., and Schmid, S. E. 1979. Handbook of Graphic Presentation, 2d ed., Ronald Press, N.Y.
33. Schnick, R. A., et al. 1982. "Mitigation and Enhancement Techniques for the Upper Mississippi River System and Other Large River Systems," Resource Publication 149, US Fish and Wildlife Service.
34. Sheng, Y. Peter, and Butler, H. Lee. "Modeling Coastal Currents and Sediment Transport," Paper given as handout at 1983 Numerical Modeling for Engineers Training Course.
35. Sheppard, S. R., and Newman, S. 1979. "Prototype Visual Impact Assessment Manual," School of Landscape Architecture, State University of New York.
36. Simmons, H. B. 1965 (Mar). "Channel Depth as a Factor in Estuarine Sedimentation," Technical Bulletin No. 8, Committee on Tidal Hydraulics, US Army Engineer Waterways Experiment Station, Vicksburg, Miss.
37. Smith, M. H., and Doiron, P. L. 1980. "Management of Water Quality Data Within the Corps of Engineers, 1979," Miscellaneous Paper E-80-2, US Army Engineer Waterways Experiment Station, Vicksburg, Miss.
38. Snedecor, G. W., and Cochran, W. C. 1967. Statistical Methods, 6th ed., Iowa State University Press, Ames.
39. Sokal, R. R., and Rohlf, F. J. 1969. Biometry, Witt Freeman Company, San Francisco, Calif.

40. Thomas, W. A. 1976. "Hydrologic Engineering Methods for Water Resources Development; Vol 12, Sediment Transport," US Army Engineer Hydrologic Engineering Center, Davis, Calif.
41. Trawle, M. J. 1981. "Effects of Depth on Dredging Frequency; Report 2, Methods of Shoaling Analysis," Hydraulics Laboratory, US Army Engineer Waterways Experiment Station, Vicksburg, Miss.
42. Tukey, J. W. 1977. Exploratory Data Analysis, Addison-Wesley, Menlo Park, Calif.
43. Urban Research and Development Corporation. 1980 (Jul). "Recreation Carrying Capacity Handbook Methods and Techniques for Planning, Design and Management," Instruction Report R-80-1, US Army Engineer Waterways Experiment Station, Vicksburg, Miss.
44. US Army Corps of Engineers. 1971. "Estuarine Navigation Projects," Technical Bulletin No. 17 (Jan), Committee on Tidal Hydraulics, Washington, D.C.
45. US Army Engineer Waterways Experiment Station. 1976. "Ecological Evaluation of Proposed Discharge of Dredged or Fill Material into Navigable Waters," Miscellaneous Paper D-76-17, US Army Engineer Waterways Experiment Station, Vicksburg, Miss.
46. US Army Engineer Waterways Experiment Station. 1984. "Open Channel Flow and Sedimentation (TABS-2), User's Manual," US Army Engineer Waterways Experiment Station, Vicksburg, Miss.
47. US Department of the Army, Office, Chief of Engineers. 1984. "Environmental Engineering for Shallow-Draft Navigation Projects," Engineer Manual in preparation.
48. US Environmental Protection Agency. 1979. "Methods for Chemical Analysis of Water and Wastes," Report No. EPA-600-4-79-020, Environmental Monitoring and Support Laboratory, Cincinnati, Ohio.
49. US Environmental Protection Agency/US Army Corps of Engineers Technical Committee on Criteria for Dredged and Fill Material. 1977 (Jul) (reprinted Apr 1978). "Ecological Evaluation of Proposed Discharge of Dredged Material Into Ocean Waters; Implementation Manual for Section 103 of Public Law 92-532 (Marine Protection, Research, and Sanctuaries Act of 1972)," US Army Engineer Waterways Experiment Station, Vicksburg, Miss. (NTIS No. AD-A103788).
50. US Fish and Wildlife Service. 1980. "U. S. Fish and Wildlife Service Mitigation Policy," Federal Register, Vol 46, No. 15 (23 January 1982), pp 7644-7663.
51. US Geological Survey. 1972. "Recommended Methods for Water-Data Acquisition."



52. US House of Representatives, Committee on Public Works. 1973. "Laws of the United States Relating to Water Pollution Control and Environmental Quality," 93-1, US Government Printing Office, Washington, D.C.
53. Vanoni, V. A., ed. 1975. Sedimentation Engineering, American Society of Civil Engineers, New York, N.Y.

APPENDIX B

MATHEMATICAL MODELING

B-1. Introduction.

a. Models. Three types of models are pertinent in the investigation of the environmental impact of deepening navigation channels:

(1) Hydrodynamic models which describe the velocity and salinity distributions within the study area.

(2) Water quality models which predict physical characteristics and chemical constituent concentrations of the water at various locations within the study area.

(3) Ecological models which predict the interactions between water quality and the aquatic community.

b. Database. The information derived from hydrodynamic models forms part of the database for water quality and ecological models, and the data from water quality models form part of the database for ecological models. Hence, it is essential that these foundation modeling activities be accomplished with adequate accuracy. The various models described require input data which may be classified as:

(1) Data that describe the initial state of the system.

(2) Data that describe the "boundary conditions" of the system. These data include system geometry and the quantity and constituent concentrations of freshwater inflows.

(3) Other data necessary for the calibration of the models, including a description of the hydrography of the study area. Because no model study can be more accurate than the information on which it is based, the importance of adequate field data cannot be overemphasized.

B-2. Field Data. The first steps in any model study must be the specification of objectives; an assessment of the geophysical, chemical, and biological factors involved; and collection of data essential to describe these factors. Assessment and data collection should include:

a. Identification of freshwater inflow sources, including their average, range, and time distribution of flow.

b. Assessment of the tides and currents that are anticipated within the region.

c. Assessment of wind effects and other geophysical phenomena that may be peculiar to the specific study.

d. Identification of the sources of sedimentation and of sediment types.

29 May 87

e. Identification of sources and the expected quantities and composition of industrial and municipal effluents, nonpoint contaminants, and tributary constituent concentrations.

f. Identification of the aquatic community of the region and the chemical, physical, and biological factors which influence its behavior.

g. Identification of the available hydrographic and other geometric data pertinent to preparation of the model.

The purpose of the preliminary assessment of pertinent and available data is to provide a basis for the selection of the models needed and to provide a basis for planning field data acquisition programs. The most satisfactory procedure is to plan the numerical modeling and field data acquisition program together. If possible, the basic hydrodynamic model should be operational during the period in which field data are being obtained. One major reason for concurrent model simulation and data acquisition is that anomalies in field data frequently occur, and the numerical model may be used to identify and resolve them.

B-3. Data Requirements. Data that are typically needed for hydrodynamic models include time history measurements of water surface elevations, velocities, and salinities. In conjunction with the field data acquisition program and the projected numerical modeling activity, a program of data analysis must be undertaken. For the data analysis program to be as efficient as possible, the field data should be recorded on media that can be automatically read by the computer equipment used in processing.

B-4. Data Analysis.

a. Elements. Data analysis includes isolation of the astronomical tide from the tidal record and an identification of the constituents of the astronomical tide. The purpose of separating the astronomical tide from the observed tide is twofold:

(1) This separation allows one to examine the residual and, by using statistical methods, to investigate the extent to which other geophysical phenomena, such as wind, influence the observed flow.

(2) The astronomical tide is deterministic and may be used in synthesizing tidal records for extreme and unusual events or during periods for which tidal records are not available.

b. Observations. Two observations need to be considered:

(1) The astronomical tide is somewhat dependent on freshwater inflows into the study region, and the amplitude of the tidal constituents therefore tends to vary seasonally in many coastal areas.

(2) Past experience in the analysis of tidal data in conjunction with model studies has shown that a minimum of about 30 days of record for tidal elevation, velocity, and salinity data is essential for satisfactory analysis.

29 May 87

## B-5. Hydrodynamical Models.

a. General. Numerical models of hydrodynamic and water quality processes are said to be coupled if they are run simultaneously and interactively on a digital computer. If, conversely, the hydrodynamic model was run and the output from it used as input to the water quality model, the two models would be said to be uncoupled. In many instances it is more economical to run uncoupled models. Uncoupled models are unacceptable where thermal gradients or the concentration of dissolved or suspended material causes a large enough variation in the fluid density to substantially affect the flow. The various numerical models may be classified as one-, two-, or three-dimensional. The one-dimensional models treat the system by averaging over a succession of cross sections. One-dimensional models are well suited to geometric situations such as channels with relatively uniform cross-sectional shapes and center lines whose radius of curvature is relatively large compared with the width, provided the water density is uniform over the cross section. Two-dimensional models may be either depth or breadth averaged. Two-dimensional depth-averaged models are the type most commonly employed and are well suited to studies in areas such as shallow estuaries, where the water column is relatively well mixed. Breadth-averaged models are used in studies of relatively deep and narrow bodies of water with significant variation of density vertically through the water column. Three-dimensional models are relatively new and have been used in only a very limited number of practical studies. In general, two-dimensional models are substantially more expensive to run than one-dimensional models, and three-dimensional models are much more expensive than two-dimensional models. Hence, in situations where it is known that one of the simpler models will produce satisfactory results, the simpler model should be employed for economy.

b. Two-Dimensional Depth-Averaged Models. Two-dimensional depth-averaged models are most commonly employed in the investigation of tidal flows in inlets, bays, and estuaries. Two distinctly different formulations have been employed: finite difference and finite element. Models currently used at WES are mentioned briefly below. The finite difference model, WIFM (WES Implicit Flooding Model) evolved from early work by Leendertse (1967). The model and its application have been described at different stages of development by Butler (1979). The finite element flow model of Research Management Associates (RMA-2) (King and Norton 1978) evolved from work by Norton et al. (1973) sponsored by Walla Walla District. The WES version of this model and a companion sediment transport model, STUDH, and their application to project studies have been described by McAnally et al. (1984). A user's manual (US Army Engineer Waterways Experiment Station 1984) for these finite element models and support programs (system called TABS-2) is nearing completion. Most existing finite difference models employ Cartesian coordinates which, even with variable grid spacing capabilities, may lead to undesirable approximations in schematization of complex study areas. Recent work by Johnson (1980) has resulted in a finite difference model (VAHM) for flow and transport which employs a generalized coordinate transformation technique called boundary-fitted coordinates to overcome this limitation. Development of this approach is continuing.

c. Two-Dimensional Breadth-Averaged Models. Breadth-averaged models are applicable in studies of relatively deep, narrow channels with small radii of

29 May 87

curvature in which lateral secondary currents of appreciable magnitude do not develop. Since fewer systems meet this criterion, work on models of this type has been more limited than on the depth-averaged models. However, work over the last few years has produced a useful model, LAEM (Laterally Averaged Estuarine Model) (Edinger and Buchak 1981). This model has been used to investigate the effect of navigation channel deepening on salinity intrusion in the Lower Mississippi River.

d. Three-Dimensional Models. Breadth- and depth-averaged two-dimensional models obviously lack the ability to predict secondary flows involving the plan that has been averaged. In some instances, these secondary currents may be appreciable and affect such things as salinity intrusion, sediment transport, thermal distribution, and water quality. Leendertse et al. (1973) pioneered the development of one of the early three-dimensional models of an estuary. Leendertse's model employed Cartesian coordinates. A three-dimensional model that uses "stretched coordinates" in both the horizontal and vertical dimensions has been developed and was applied in preliminary studies of the Mississippi Sound (Sheng and Butler 1983). Research level three-dimensional versions of the finite element flow and sediment models have also been developed and are being evaluated (Ariathurai 1982 and King 1982). Improvements in the efficiency of computational equipment and modeling technology are increasing the feasibility of applying three-dimensional models. Such models are, however, on the experimental frontier of what may reasonably be done with numerical models.

#### B-6. Water Quality Models.

a. General. Historically, the analysis of water quality has concentrated on the dissolved oxygen (DO) and biochemical oxygen demand (BOD). The balance between DO and BOD concentrations was the result of two processes: the reaeration of the water column, and the consumption of DO in oxidation of BOD. Later emphasis has been on extending and refining the Streeter-Phelps formulation by using a more generalized mass balance approach and by the inclusion of additional processes such as benthic oxygen demand, benthic scour and deposition, photosynthesis and respiration of aquatic plants, and nitrification. The more comprehensive water quality models have been developed to include the nitrogen and phosphorus cycle and the lower trophic levels of phytoplankton and zooplankton. A number of investigations have modeled the algal nutrient silica. Selected chemical constituents have been modeled by assuming thermodynamic equilibrium. The fate of toxicants such as pesticides, metals, and PCBs is very complicated involving adsorption-desorption reactions, flocculation, precipitation, sedimentation, and biological uptake. Examination of toxicants and their impact on biological populations requires ecological models. Selection of a water quality methodology requires consideration of the following:

- (1) Water quality constituents.
- (2) Dimensional and temporal resolution.
- (3) Data requirements.

29 May 87

b. Water Quality Constituents. The water quality constituents most frequently simulated include salinity, light, temperature, DO, BOD, coliform bacteria, algae, nitrogen, and phosphorus. Each of these constituents interacts with the others, but the significance of their dependencies varies among constituents, and their inclusion in a numerical water quality model depends upon the study objectives and the water body under consideration. The environmental impact analysis of most deep-draft navigation projects can use salinity and DO as indices of environmental change.

(1) Salinity plays a dominant role in physicochemical phenomena such as flocculation of suspended particulates, is used as a variable to define the habitat suitability for aquatic organisms, and is frequently employed as a conservative tracer to calibrate mixing parameters.

(2) Dissolved oxygen is a respiratory requirement for most organisms and is used as a measure of the "health" of aquatic systems. Dissolved oxygen can be used to evaluate the environmental significance of stratification resulting from channel deepening and realignment.

c. Dimensional and Temporal Resolution. In a numerical water quality model the choice is between a one-dimensional model and one that incorporates two or three spatial dimensions. A long, narrow, and vertically well-mixed water body may be represented by a one-dimensional model consisting of a series of segments averaged over the cross section. Where there is pronounced vertical stratification, it is likely that a laterally averaged two-dimensional model will be needed. In other situations where there are marked lateral heterogeneities in water quality but the water body is well mixed, a vertically averaged two-dimensional model is indicated. If significant lateral heterogeneities are accompanied by pronounced stratification, a three-dimensional model may be required. Most existing water quality models are one-dimensional. Practical applications of two-dimensional depth- and breadth-integrated models have been made and are feasible. Three-dimensional water quality models are presently research tools; data requirements for calibration and verification make them prohibitively expensive at present for practical application. The basis of all water quality models is a velocity field either specified by empirical measurements or computed by numerical hydrodynamic models. The current trend in hydrodynamic modeling is toward development of three-dimensional models with increased spatial and temporal resolution in order to resolve important scales and to minimize the need for parameterization. As a result, modern time-dependent hydrodynamic models normally have time steps on the order of minutes to one hour. The chemical and biological equations of water quality models have characteristic time scales determined by the kinetic rate coefficients. These time scales are usually on the order of one to ten days. The phenomena of interest, such as depletion of DO and excessive plant growth, occur on time scales of days to several months. Direct coupling of hydrodynamic and water quality models provides potential spatial and temporal resolution that cannot be effectively interpreted. The reasons are that present field sampling programs resolve constituent concentrations on the order of a kilometer to tens of kilometers in the horizontal, meters in the vertical, and days to weeks in time. In addition, the kinetic rate coefficients presently used in water quality models resolve dynamics on the order of days to weeks. Direct coupling substantially increases the cost of computation. Direct coupling is necessary only for those constituents such as temperature, salinity,

29 May 87

and suspended particulates, whose contribution to density gradients may substantially affect the flow. Uncoupling permits averaging of the hydrodynamic model output, which results in less costly water quality computations.

**B-7. Ecological Models.** Ecological models include numerous biological species and emphasize food chain and species interactions. Ecological models are appropriate for addressing toxicants such as pesticides, metals, and PCBs and evaluating small incremental changes in nutrients, suspended particulates, and temperature. No general ecological model exists. Existing ecological models are site specific, dependent upon the local aquatic community, and specific to the toxicant of concern. The Environmental Laboratory at WES serves as a clearinghouse for Corps inquiries, and plans to become an active participant in ecological model application.

**B-8. Modeling Systems.** In this appendix, consideration has been given to some of the more important aspects of numerical model selection and application. Hydrodynamic, water quality, and ecological models may not be considered as individual entities. As explained, the various models must be coupled, or the output of one model must be used as input to a subsequent model. If the applicable models are to be used efficiently and economically, the data transfer between the models must be considered and steps must be taken to ensure output-to-input compatibility. In modeling there are, in addition to the modeling itself, data to be collected, analyzed, and put into appropriate databases. Each of these activities requires substantial data processing, and the aggregate cost of these activities may far exceed the cost of the actual modeling exercise. Also associated with most studies are other requirements, such as reports, which lead to additional data processing for such activities as computer graphics. The development of the models and other programs requires a broad spectrum of technical talents, and the execution of a comprehensive study may require the interaction of several individuals. What is essential to an effective study is a comprehensive, integrated system of modeling and utility programs, which is documented to the extent that the system may be understood and used by the various individuals participating in the study. Such systems are beginning to emerge. The WES Hydraulics Laboratory has developed a system for Open Channel Flow and Sedimentation (TABS-2) which uses depth-averaged finite element models to predict hydrodynamics, salinity, and sediment transport. The WES Environmental Laboratory is incorporating mass transport equations which include the chemical reaction terms in the two-dimensional, depth-averaged model WIFM (paragraph C-5), the transport portion of the boundary-fitted coordinate model VAHM (paragraph C-5), and the two-dimensional, breadth-averaged model LAEM (paragraph C-5). The emergence of such systems is a significant aspect of the advancement of numerical modeling.

## APPENDIX C

### USE OF PHYSICAL HYDRAULIC MODELS AS TOOLS IN DEEP-DRAFT ENVIRONMENTAL STUDIES

#### C-1. Introduction.

a. Earlier sections of this EM discuss specific considerations which must be addressed to evaluate the impacts of deep-draft navigation channels on water quality and biological or ecological conditions. One of the tools that can be (and has been) applied to make the necessary predictions of these conditions is physical hydraulic modeling. This appendix gives a brief description of physical hydraulic modeling and its relation to other methods. It is intended to familiarize engineers and scientists with the use of this technique in preparing impact studies. The relative strengths and weaknesses are discussed so that, depending on the specific situation, physical hydraulic models might be effectively considered in a modeling strategy. The basis and methods used in physical modeling are also briefly described.

b. For projects in which dependable, accurate results warrant the additional expense, a physical model study is recommended. This approach is especially recommended if the system is partially mixed or stratified in vertical salinity structure, or if it has a complicated geometry. Guidance for initiating physical (hydraulic) model studies is given in ER 1110-1-8100, ER 1110-2-1403, and related ERs. Estuarine studies performed at WES usually take 18 to 48 months and cost roughly \$20 per square foot of model and \$20,000 per month.

#### C-2. Physical Hydraulic Models.

a. Physical hydraulic models are scaled representations of a waterway area under study. Figure D-1 shows a physical model of New York Harbor. Naturally, models are at reduced scale; usually one foot (horizontal) in a model equals 500 to 1000 feet in the prototype (the actual waterway). Seawater supply, tide generators, and gaged freshwater inflows are appurtenances. The models are usually molded in concrete between closely spaced templates. Instrumentation is mounted on models or samples are drawn from them to measure such attributes as water surface elevation, current speed and direction, salinities, and tracer concentration. Tracers are often photographed to qualitatively examine their behavior or patterns of flow. Hudson et al. (1979) give a more detailed description of physical hydraulic models.

b. Boundaries and features of models should be planned carefully. A physical hydraulic model is designed and constructed to include the region of interest and other areas necessary so that boundary data or conditions can be satisfactorily applied. If the effects on assimilative capacity of the waterway are to be tested, effluent outfalls or diffusers are included in model design and construction. If all the modifications to be tested in the model are known at the time of model design, provisions can be made to make them quickly and less expensively.





Figure D-1. Physical model, New York Harbor

C-3. Comparison to Other Methods.

a. Other methods for testing large-scale physical changes, such as deep-draft channels, include testing in the prototype, analytical techniques, and numerical modeling. Prototype tests and analytical techniques are rarely employed since they tend to be impractical due to their expense or difficulty due to uncontrollable conditions. Thus, only physical hydraulic and numerical models of estuaries will be compared herein. Physical hydraulic modeling of estuaries was first used in the last century and has increased steadily in this country since the 1930s. Numerical modeling in multiple spatial domains has been practiced only since the mid-1960s. Both methods are developing. Physical hydraulic modeling has been refined by the use of automated model control and data acquisition, by advances in instrumentation, by postconstruction model evaluation, and by research on model mixing processes.

b. Physical hydraulic models have been used to study the effects of channel deepening. They have been used successfully to predict tidal currents, circulation, riverflows, salinity distributions, waste effluent dispersion, and exchange rates of estuarine environments. These conditions are a result of a number of processes, many of which are three-dimensional and nonlinear in character. If these conditions are of central concern to a study, the physical modeling approach should be considered best. Physical hydraulic models are real and therefore offer the only means of representing the region of interest as a three-dimensional continuum whose resolution is limited only by the availability of topographic data. Many of the physical processes responsible for variability in the estuarine environment can be represented in physical hydraulic models, including vertical density effects, which are important in most deep-draft studies. The strong points of physical hydraulic models when compared with numerical models are:

- (1) Several processes may be evaluated in one model.
- (2) Three-dimensional effects are included.
- (3) Salinity can be best represented.
- (4) Long simulations are practical.
- (5) Operating costs are lower in some cases.

c. The last two items are related. Numerical models can be run for long periods, but this can be costly and stability problems sometimes arise. However, physical hydraulic models can also be costly. Physical hydraulic models can be operated over multiple spring-to-neap tidal cycles or with long freshwater inflow hydrographs. The importance of this capability will be discussed later. Physical models can include point source discharges and represent their behavior relatively near to this source. The major disadvantages of physical hydraulic models are their high initial cost and possible scale or scale-distortion effects on dispersive transport and bed shear stress. Construction and verification of physical models take time and are relatively expensive. To counteract scale effects, mixing is adjusted by distributing roughness or friction, in some cases, by applying supplemental mixers.

d. Cost and speed of application are advantages of numerical modeling. However, since both methods require that basically the same field data be collected, time might not be an advantage. Most numerical models are averaged in one or more dimensions and solve equations that are simplified by parameterizing mixing and dispersion processes into coefficients. These coefficients are generally unknown and change in space and time. The numerical modeler must attempt to match these coefficients to processes that are known to be scale dependent. Numerical models generally overestimate near-field or small-scale dispersion.

e. With the exception of salt concentration, the attributes and processes represented in physical hydraulic models are physical, not biological or chemical. Therefore, many complex chemical and biological systems that may be of interest in estuaries may not be represented in physical models. In many cases, physical processes dominate these conditions and deserve priority consideration. The strength of the physical modeling approach is in the representation of these processes. The strong points of the numerical approach are the ability to represent large numbers of nonconservative constituents, either chemical or biological, and to more accurately model sedimentation processes.

#### C-4. Modeling Practice.

##### a. Similitude.

(1) Similarity between the physical hydraulic model  $m$  and the prototype  $p$  must be defined so that every point in time, space, and process can be uniquely coordinated. This is done by introducing scaling laws based on the Froude number equality:

$$(\text{velocity})^2 / (\text{gravitational acceleration} \times \text{depth}) \quad (p = m)$$

and is extended by dimensional analysis of equations that apply to both the model and the prototype. A distortion can exist if two variables or parameters representing the same physical property are sufficiently independent so that they can be given different scale ratios. Physical hydraulic models of estuaries are almost always distorted in length scale such that the horizontal scale  $L_x$  and the vertical scale  $L_z$  are not equal. This is done to reduce scale effects, maintain turbulent flow in the model, and minimize model construction costs. Scale ratios  $p/m$  for some of the attributes of interest are:

$$\text{time} = \frac{L_x}{\sqrt{L_z}}$$

$$\text{horizontal velocity} = L_z^{1/2}$$

$$\text{vertical velocity} = \frac{L_z^{3/2}}{L_x}$$

$$\text{horizontal diffusion and dispersion} = L_z^{1/2} L_x$$

$$\text{vertical diffusion} = \frac{Lz^{5/2}}{Lx}$$

(Salinity/density ratios are generally taken as unity.)

(2) It may not be possible to satisfy all the similarity scaling laws, in which case other ratios are defined to describe the expected deviation in model behavior. Point source discharges, such as from outfalls and diffusers, are specially scaled in models to maintain turbulence and achieve similarity in near-field behavior.

b. Model Verification. The first step after model construction is model calibration and verification. Extensive prototype data collection and analysis programs are required to provide the information necessary for calibration or adjustment of the model. Such data should cover the range of boundary data that will be used in the testing program, as far as possible. Usually tide heights are adjusted first, followed by currents and salinity. During the verification period, model-to-prototype comparisons are made. Model repeatability is normally addressed at this point in the modeling program, which checks the assumption that the behavior of the system depends uniquely on the boundary data imposed. Small-scale mixing processes that depend on turbulence are probabilistic and will not repeat exactly.

c. Test Procedures.

(1) After the verification phase is complete, model base (no modification) and plan (modifications installed) tests are performed. Boundary data and sampling locations are selected based on some frequency of occurrence and on expected gradients, respectively. Test data routinely include water surface elevations, currents, and salinities and might also include effluent, sediment, or dye tracer concentrations, depending on the conditions being tested. Velocities, salinities, and tracer concentrations can be subjected to statistical analysis to determine the relative contributions of circulation and gradient diffusion on mixing. Tracer concentrations can also be used to estimate exchange rates, purging rates, or shoaling rates. If necessary, effluent concentrations can be analytically corrected for decay processes. In general, base tests provide an opportunity to observe model behavior and elucidate or identify patterns in this behavior, often leading to a better understanding of the dominant processes in the prototype. Plan tests then provide a measure of the impacts of the modification on the conditions of interest and the desirability of this impact.

(2) Selecting boundary data and their variability requires some consideration. Constant boundary data, such as a steady inflow and repetitive diurnal or semidiurnal tide, result in conditions varying with the tidal frequency. Data collection is simplified because it can be moved from station to station and observations will be comparable (quasisynoptic). Variable boundary data might consist of a spring-to-neap varying tide. This makes synoptic data collection more difficult. If the inflow is steady, successive neap-to-spring cycles can be sampled at different stations. If the inflow varies, a slack-water sampling scheme may be indicated. Despite these sampling problems, the variation from spring-to-neap tide causes important effects on salinity

EM 1110-2-1202  
29 May 87

distributions and circulations in some estuaries not observable using constant boundary data. It is recommended that spring-to-neap tidal cycles be incorporated into at least some phase of model testing.

## GLOSSARY

### TERMS

Absorption: The taking up of matter in bulk by other matter, as in the dissolving of a gas by a liquid.

Adsorption: The adherence of substances to the surfaces of bodies with which they are in contact, but not in chemical combination.

Advection: The process of transport of water, or of an aqueous property, solely by the mass motion of the fluid, typically via horizontal currents.

Aerobic: Requiring or existing in the presence of oxygen.

Agitation dredging: The removal of bottom material from a selected area by using equipment to raise it temporarily in the water column and allow water currents to carry the material away.

Anadromous: Those fish, such as salmon, steelhead, and shad, that ascend freshwater streams to spawn.

Anaerobic: Existing in the absence of oxygen; as opposed to aerobic.

Aquifer: Subsurface geological stratum containing water.

Bathymetry (bathymetric): The measurement of ocean depths in order to determine seafloor topography.

Beach nourishment: The process of replenishing a beach; use of sand to increase or improve beach area.

Bedforms: Ripples, waves, dunes, and related forms that develop under various flow conditions on the beds of alluvial streams with significant bedload transport.

Bedload: Sediment, usually sand size or larger, that is transported along the bed by rolling, skipping, dragging, or saltation.

Benthic macroinvertebrates: Large invertebrates found on or within bottom sediments and consisting largely of larval insects, worms, and related organisms.

Benthic organisms: Bottom-dwelling aquatic organisms.

Bioaccumulation: The uptake and incorporation of material into an organism as a result of its normal physiological processes.

Bioassay: Determination of the physiological effect of a substance by observing its effects on suitable living organisms under controlled conditions.

Biological magnification: Increasing concentration of relatively stable chemicals as they are passed up a food chain from initial consumers to top predators.

Biota: Organisms inhabiting an ecosystem.

Brackish: Moderately saline.

Braided channel: A channel pattern characterized by numerous intertwined channelways.

Breakwater: A structure built into the sea to protect a shore area, harbor, anchorage, or basin from the action of the waves.

Circulation: The flow or motion of fluid in or through a given area or volume.

Climax community: A mature, relatively stable biotic community representing the culmination of ecological succession.

Community: All of the populations of plants and animals in an area or volume; a complex association usually containing both animals and plants.

Controlling depth: Actual minimum depth of a waterway at its shallowest point.

Design vessel: A hypothetical vessel which has characteristics of the largest and least maneuverable vessels that a project is designed to accommodate.

Diatom: The common name for silicon-containing algae.

Dispersion: The scattering of particles or a cloud of contaminants or foreign matter by the combined effects of shear and transverse diffusion.

Ebb tide: The portion of the tide cycle between high water and the following low water. Also known as a falling tide, with seaward currents.

Ecosystem: A community and its environment (living and nonliving) considered collectively the fundamental unit in ecology. May be quite small, as the ecosystem of one-celled plants in a drop of water, or indefinitely large, as in the grassland ecosystem.

EIS (Environmental Impact Statement): A statement required under NEPA which assesses the ecological, social, and aesthetic effects of a project or action upon the environment. Included in such a statement is a quantified assessment of the area before the project or action, a quantified assessment of the impacts anticipated from the action, a review of feasible alternatives to the action, a discussion of mitigating measures, a discussion of the short-term benefits versus long-term effects, and a discussion of those resources irretrievably lost by such action.

Epifauna: Surface-dwelling aquatic organisms.

Estuary: A semienclosed coastal body of water that has a free connection with the open sea and within which seawater is measurably diluted with fresh water. Part of the river affected by tides; region of the river mouth where the fresh water of the river meets the saltwater of the sea.

Euphotic: Of or constituting the upper levels of the marine environment down to the limits of effective light penetration for photosynthesis.

Eutrophication: The process of a body of water becoming better nourished either naturally by processes of maturation or artificially by fertilization. Nutrient concentration and primary production tend to increase as eutrophication proceeds.

Extrapolation: Estimating a function at a point which is larger than (or smaller than) all the points at which the value of the function is known.

Flood tide: The portion of the tidal cycle between low water and the next high water; the highest tidal elevation; a rising tide.

Food chain: Animals linked together by predator-prey relationships and all dependent, in the long run, on plants.

Habitat: The physical location in which a population of plants or animals lives.

Hermatypic: Reef-building coral characterized by the presence of symbiotic algae within their endodermal tissue.

Hydrodynamics: The branch of physics dealing with the movements of water and other liquids.

Ice booms: Devices to restrict the movement of ice at critical waterway sites.

Infauna: Aquatic animals that live in the bottom sediment of a body of water.

Interpolation: A process used to estimate an intermediate value of one (dependent) variable which is a function of a second (independent) variable when values of the dependent variable corresponding to several discrete values of the independent variable are known.

Isobath: A contour line connecting points of equal water depths on a chart.

Jetty: A barrier built out from a seashore or riverbank to protect the land from erosion and sand movements, among other functions. Also known as groin, groyne, spurdiike, and wing dam.

Kinetic rate coefficient: A temperature-dependent variable that relates the concentrations of chemical compounds which are involved in a reaction.

Leaching: The removal of materials from a solid medium due to erosion or dissolution occurring because of the passage of water or other fluid through the medium.



Lentic: Of or pertaining to still waters, i.e., lakes.

Limnetic: Of, pertaining to, or inhabiting the pelagic region of a body of fresh water.

Littoral zone: Shallow-water area between the high- and low-water extremes.

Lotic: Of or pertaining to swiftly moving waters.

Low-flow augmentation: The release of water to increase flow in low-flow periods.

Minimum flow requirements: Lowest legal or traditional flows specified for a waterway.

Neap tide: Tide of decreased range occurring about every two weeks when the moon is in quadrature, that is, during its first and last quarter. Also known as neaps.

Nekton: Free-swimming organisms of open water, large and strong enough to be independent of turbulent water movement (fish).

NEPA (National Environmental Policy Act): A Federal policy enacted in 1969 and calling for an impact analysis of many major Federally funded actions which significantly affect the quality of man's environment.

Neritic: Of or pertaining to the region of shallow water adjoining the sea-coast and extending from low-tide mark to a depth of about 600 feet.

Neuston: Minute organisms that float or swim on the water surface.

Nitrification: A step in the nitrogen cycle technically involving oxidation of nitrogen, e.g.  $\text{NH}_3$  from ammonia to nitrates ( $\text{NO}_3$ ). Soil-dwelling (chemosynthetic) bacteria nitrify ammonia in two steps to nitrite ( $\text{NO}_2$ ) and to nitrate ( $\text{NO}_3$ ), in which form it is most available to plants.<sup>2</sup> Chemical reduction of nitrogen, as to  $\text{N}_2$ , is denitrification.

Oxidation: A chemical reaction that increases the oxygen content of a compound that, hence, loses electrons.

Pelagic organisms: Midwater aquatic organisms, i.e., ones that never touch the bottom strata.

Periphytic: Pertaining to sessile biotal components of freshwater ecosystems.

Photosynthesis: Synthesis of reduced compounds using light energy, especially the manufacture of organic compounds (primarily carbohydrates) from carbon dioxide and a hydrogen source (such as water) with simultaneous liberation of oxygen by chlorophyll-containing plant cells.

Phytoplankton: Planktonic plant life.

Plankton: Small organisms (animals, plants, or microbes) passively floating in water; macroplankton are relatively large (1.0 mm to 1.0 cm); mesoplankton are of intermediate size; microplankton are much smaller.

Population: A group of organisms of the same species.

Pseudofeces: Coarse particles that accumulate at the edges of the palps of filter-feeding bivalve animals and are periodically thrown off by muscular twitches onto the mantle wall. This material never enters the gut and is expelled from the bivalve by spasmodic contractions of the adductor muscles.

RCRA: Resource Conservation and Recovery Act.

Reduction: A chemical reaction that decreases the oxygen content of a compound and, hence, that compound gains electrons.

Regression: A functional relationship between two or more variables that is often empirically determined from data and is used to predict values of one variable when given values of the others.

Revetment: A facing built on an embankment to prevent scour by weather or water.

Salmonid or salminoid: Collective term referring to salmon, trout, grayling, or white fish. All of these species prefer coldwater environments.

Saltation: Movement of sediment along a channel bed by intermittent bouncing.

Sediment basin: A basin constructed to trap sediment eroded from a slope or being transported by a stream.

Sessile: Permanently attached to the substrate.

Shear stress: Stress imposed on the streambed and banks by flowing water.

Shoaling: The reduction of water depth due to sediment deposition.

Similitude: Correspondence between the behavior of a model and its prototype.

Spring tide: Tide of increased range that occurs about every two weeks when the moon is new or full.

Stratification: In a body of water, layering of less dense water over underlying more dense water. Usually caused by salinity or temperature differences.

Substrate: Surface to which stream biota adhere or within which they live.

Suspended load: That portion of a stream's sediment load that is carried in suspension.

Thalweg: A line connecting the deepest points along a channel.

Trophic: Pertaining to, or functioning in, nutrition.

EM 1110-2-1202  
29 May 87

Turning basin: An open area along or at the end of a waterway or harbor to allow vessels to turn around.

Water quality: An assessment of the condition of water in relation to some goal.

Water quality criteria: Statements concerning the limiting values for water quality parameters in light of a specific intended water use.